



Videojet 1560

Operator Manual

P/N 462534-01
Revision: AA, July 2015

Copyright July 2015, Videojet Technologies Inc. (herein referred to as Videojet). All rights reserved.

This document is the property of Videojet Technologies Inc. and contains confidential and proprietary information owned by Videojet. Any unauthorized copying, use or disclosure of it without the prior written permission of Videojet is strictly prohibited.

Videojet Technologies Inc.

1500 Mittel Boulevard
Wood Dale, IL
60191-1073 USA
www.videojet.com

Phone: 1-800-843-3610
Fax: 1-800-582-1343
Int'l Fax: 630-616-3629

Offices - USA: Atlanta, Chicago
Int'l: Canada, France, Germany, Ireland, Japan, Spain,
Singapore, The Netherlands, and The United Kingdom
Distributors Worldwide

Compliance Information

For Customers in the European Union

This equipment displays the CE mark to indicate conformance to the following legislation:

EN 55022: Class A	Emissions Standard for industrial environments
EN 61000-6-4	Generic Emissions Standard for Heavy Industrial Environments
EN61000-3-2	Harmonic Current Fluctuations
EN61000-3-3	Voltage Fluctuation and Flicker
EN61000-6-2	Immunity Characteristics for Industrial Environments

Following the provisions of **EU EMC Directive 2004/108/EC**

EC Low Voltage Directive 2006/95/EC

Essential health and safety requirements relating to electrical equipment designed for use within certain voltage limits.

IEC 60950-1(ed.2)

EN60950-1

Safety requirements for information technology equipment including electrical business equipment.

EN 60529

Degrees of protection provided by enclosures (IP Code).

For Customers in the U.S.A.

This device complies with Part 15 of the FCC Rules. Operation is subject to the following two conditions: 1) this device may not cause harmful interference, and 2) this device must accept any interference received, including interference that may cause undesired operation.



Warning

Changes or modifications to this unit not expressly approved by the party responsible for compliance could void the user's authority to operate the equipment.

This equipment has been tested and found to comply with the limits for a Class A digital device, pursuant to Part 15 of the FCC Rules. These limits are designed to provide responsible protection against harmful interference when the equipment is operated in a commercial environment. This equipment generates, uses, and can radiate radio frequency energy and, if not installed and used in accordance with the

instruction manual, may cause harmful interference to radio communications. Operation of this equipment in a residential area is likely to cause harmful interference in which case the user will be required to correct the interference at his own expense.

Shielded cables must be used with this unit to ensure compliance with Class A FCC limits.

The user may find the following booklet prepared by the Federal Communications Commission helpful: How to Identify and Resolve Radio-TV Interference Problems. This booklet is available from the U.S. Government Printing Office, Washington, DC 20402, Stock No. 004-00-00345-4.

This equipment has been tested and certified for compliance with U.S. regulations regarding safety and electrical emissions by:

Electromagnetic Testing Services Limited

Pratts Fields

Lubberhedges Lane

Stebbing, Dunmow

Essex, CM6 3BT

England, UK

This equipment has been investigated by Underwriters Laboratories Inc. in accordance with the standard for safety: UL 60950-1: Safety of information technology equipment first edition. Subject 2178 marking and coding equipment, electronics.

Report reference E252185.

For Customers in Canada

This digital apparatus does not exceed the Class A limits for radio noise emissions from digital apparatus set out in the Radio Interference Regulations of the Canadian Department of Communications.

This equipment has been tested and certified for compliance with Canadian regulations regarding safety and electrical emissions by:

Electromagnetic Testing Services Limited

Pratts Fields

Lubberhedges Lane

Stebbing, Dunmow

Essex, CM6 3BT

England, UK

This equipment has been investigated by Underwriters Laboratories Incorporated in accordance with the standard for safety: CAN/CSA C22.2 No. 60950-1-03. Safety of information technology equipment. Subject 2178 marking and coding equipment, electronics.

Report reference E252185.

Pour la clientèle du Canada

Le present appareil numerique n'émet pas de bruits radioelectriques depassant les limites applicales aux appareils numerique de las class A prescrites dans le Reglement sur le brouillage radioelectrique edicte par le ministere des Communications du Canada.

Cet équipement est certifié CSA.

This equipment has been investigated by Underwriters Laboratories Incorporated in accordance with the standard for safety: CAN/CSA C22.2 No. 60950-1-03. Safety of information technology equipment. Subject 2178 marking and coding equipment, electronics.

Report reference E252185.



Warning

This product is not intended for use in the immediate/direct visual field of the display work place. To avoid disturbing reflections on the display work place, this product shall not be placed in the immediate/direct field of vision.

Customer Support and Training

Contact Information

If you have any questions or need assistance, please contact Videojet Technologies Inc. at 1-800-843-3610 (for all customers within the United States). Outside the U.S., customers should contact their Videojet Technologies Inc. distributor or subsidiary for assistance.

Videojet Technologies Inc.
1500 Mittel Boulevard
Wood Dale, IL 60191-1073 U.S.A.
Phone: 1-800-843-3610
Fax: 1-800-582-1343
International Fax: 630-616-3629
Web: www.videojet.com

Service Program

About **Total Source Commitment**

Total Source® TOTAL SERVICE PLUS RELIABILITY, is the Videojet Technologies Inc. commitment to provide you - our customer - the complete service you deserve.

The **Total Source Commitment**

The Videojet *Total Source®* Service Program is an integral part of our business in providing marks, codes, and images where, when, and how often customers specify for packages, products, or printed materials. Our commitment includes:

- Applications support.
- Installation services.
- Maintenance training.
- Customer response center.
- Technical support.
- Field service.
- Extended hours phone assistance.
- Parts and supplies.
- Repair service.

Customer Training

If you wish to perform your own service and maintenance on the printer, Videojet Technologies Inc. highly recommends you complete a Customer Training Course on the printer.

Note: The manuals are intended to be supplements to (and not replacements for) Videojet Technologies Inc. Customer Training.

For more information on Videojet Technologies Inc. Customer Training Courses, call 1-800-843-3610 (within the United States only). Outside the U.S., customer should contact a Videojet subsidiary office or the local Videojet distributor for further information.

Table of Contents

Compliance Information

<i>For Customers in the European Union</i>	<i>i</i>
<i>For Customers in the U.S.A.</i>	<i>i</i>
<i>For Customers in Canada</i>	<i>ii</i>
<i>Pour la clientèle du Canada</i>	<i>iii</i>

Customer Support and Training

<i>Contact Information</i>	<i>iv</i>
<i>Service Program</i>	<i>iv</i>
<i>Customer Training</i>	<i>v</i>

Chapter 1 — Introduction

Videojet 1560 Printer.....	1-1
About the Manual.....	1-1
Related Publications.....	1-1
Language Codes.....	1-1
Content Presentation.....	1-2
Positional References.....	1-2
Units of Measurement.....	1-2
Safety Information.....	1-2
Notes.....	1-3
User Interface Terminology.....	1-3
Abbreviations and Acronyms.....	1-4
Chapters in the Manual.....	1-4

Chapter 2 — Safety

Introduction.....	2-1
General Safety Guidelines.....	2-1
Electrical Safety Guidelines.....	2-2
Electrical Power Supply.....	2-2
Electrical Cables.....	2-3
Grounding and Bonding.....	2-3
Fuses.....	2-5
Fluid Safety Guidelines.....	2-5
Read the Material Safety Data Sheets.....	2-5
Ink and Make-up Fluid.....	2-6
Cleaning Solution.....	2-7
Compressed Air Safety Guidelines.....	2-8
UI Related Safety Guidelines.....	2-8
Other Important Guidelines.....	2-9

Chapter 3 — Main Parts

Videojet 1560 Printer	3-1
Home Page	3-2
Tools Page	3-4
Electronics Compartment	3-5
Ink Compartment	3-6
Ink Core Module	3-6
Smart Cartridge	3-7
Ink Compartment Fan	3-7
Printhead and Umbilical	3-7
Connector Panel	3-8
Pinout Information	3-10
Main Power Switch	3-10
Back Filter	3-11

Chapter 4 — Printer Operation

Introduction	4-1
How to Turn on the Printer	4-1
Getting started with the User Interface	4-2
Using the Tools Page	4-5
How to Clean/Quick Start and Stop the Printer	4-6
How to Clean/Quick Start	4-6
How to Clean/Quick Stop	4-6
How to Set the Passwords	4-7
How to Login	4-8
How to clear password	4-10
Counters	4-11
How to Reset the Counters	4-11
Run Hours	4-12
How to View Run Hours	4-12
How to Reset Run Hours	4-13
How to Configure the Serial Port	4-14
How to Enter Service Information	4-16
Printer Configuration	4-17
Print Trigger	4-18
Encoder	4-19
Advanced Features	4-20
Message Configuration	4-23
Inputs	4-23
Head Parameters	4-24
EHT/HV	4-25
System Service Operations	4-26
How to Use Continuous Print Option	4-27

DIN Print	4-28
How to Print Messages	4-29
How to Select a Message	4-29
How to Start the Printing	4-34
How to Stop the Printer	4-35
How to Stop the jet	4-35
Turn off the Printer	4-36

Chapter 5 — User Interface

Introduction	5-1
Screen Description	5-2
Buttons	5-2
Using the Tools Page	5-3
Working with Setup Page	5-3
Working with Diagnostics	5-13
Working With Databases	5-28
Working with Message Editor	5-29
Manage Messages	5-30
To Create a Message	5-30
User Fields	5-40
To Edit a Message	5-52
To Delete a Message	5-62
To Define a Prompted Field	5-63
Overall Equipment Effectiveness - Availability Tools	5-73
Introduction	5-73
Availability Page	5-75

Chapter 6 — Maintenance

Introduction	6-1
Maintenance Schedule	6-2
Preparation for Long-term Shutdown (Storage) or Transportation	6-2
Parts/tools Requirement	6-2
How to Prepare for Long-term Shutdown (Storage) or Transportation	6-3
Replace Smart Cartridges	6-4
Inspect the Printhead	6-7
Clean the Printhead	6-7
Clean the Deflector Plate	6-10
Clean the Printer Cabinet	6-11
Clean the Touch Screen	6-12

Chapter 7 — Troubleshooting

Introduction 7-1
 The Printer Does Not Start. 7-2
 Incorrect Print Position 7-3
 Incorrect Print Size 7-4
 Print Not Complete. 7-4
 Poor Print Quality 7-5
 Printer Status Icons 7-6
 Fault Messages and Warnings 7-7
 Clearing a Fault Message or Warning 7-9
 Printer Error Messages 7-11
 Ink Core Life 7-23
 Fault Messages 7-23
 Diagnostics Screen 7-24

Appendix A — Specifications

Electrical Specifications A-1
 Weight. A-1
 Dimensions A-2
 Optional Accessories A-4
 Mobile Printer Stand A-4
 Static Printer Stand A-5
 Printhead Stand A-6
 Environmental Specifications A-7
 Ink and Make-up Fluid Capacity A-7
 Print Height A-7
 Font Specifications and Line Speeds A-8
 Barcode Specifications A-9

Glossary

Introduction

1

Videojet 1560 Printer

This printer is a continuous ink jet printer that can print fixed and variable codes at elevated line speeds on consumer and industrial products. The printer delivers superior uptime, excellent print quality, and ease of use to the users.

About the Manual

This Operator Manual is written for the every day user of the printer. The Operator Manual helps the user to understand the different parts and different printing operations of the printer.

Related Publications

The following manual is available for reference:

Videojet 1560 Service Manual, Part Number: 462535.

Language Codes

When you order these manuals, make sure to add the 2-digit language code at the end of the part number. For example, the Spanish version of the operator manual is part number 462534-04. Table 1-1 on page 1-2 shows the list of language codes that you can use to identify the translated versions of this manual.

***Note:** The availability of the Operator Manual is indicated by an asterisk (*). Availability of the Service Manual is indicated by a plus sign (+). For more information, contact the Videojet distributor or subsidiary.*

Code	Language	Availability (see note)	
02	French	*	+
03	German	*	+
04	Spanish	*	+
05	Portuguese Brazilian	*	
08	Italian	*	
09	Dutch	*	
21	English (UK)	*	+
23	Polish	*	
24	Turkish	*	+

Table 1-1: List of Language Codes

Content Presentation

This Operator Manual contains different types of information like safety guidelines, additional notes, user interface (UI) terminology and so on. To help you identify the different types of information, different writing styles are used in this manual. This section describes these writing styles.

Positional References

Positions and directions like left, right, front, rear, to the right and to the left are with respect to the printer when you see from the front.

Units of Measurement

This manual uses metric units of measurement. The equivalent English measures are included in parenthesis. For example, 240 mm (9.44 inches).

Safety Information

The safety information includes warning and caution statements.

Warning

The warning statements indicate hazards or unsafe practices that can cause severe personal injury or death. For example:



Warning

PERSONAL INJURY. The cleaning solution is poisonous if taken internally. Do not drink. Seek medical attention immediately if ingested.

Caution

The caution statements indicate hazards or unsafe practices that can cause damage to the equipment. For example:



Caution

EQUIPMENT DAMAGE. Do not fit or remove any connector on the printer when the power is turned on. The failure to follow this caution can damage the printer.

Notes

Notes provide additional information about a particular topic.

For example:

Note: You can set the password protection for some functions to prevent any access that is not authorised.

User Interface Terminology

For more information on Videojet 1560 operating system, refer “User Interface” on page 5-1.

Abbreviations and Acronyms

Abbreviation	Expansion
AC	Alternating Current
CDA	Clean Dry Air
LED	Light Emitting Diode
LCD	Liquid Crystal Display
UI	User Interface
WYSIWYG	What You See Is What You Get

Table 1-2: Abbreviations and Acronyms

Chapters in the Manual

Chapter No.	Chapter Name	Description
1.	Introduction	Contains the information about this manual, the related publications, and writing styles used in this manual.
2.	Safety	Contains the safety and hazard information.
3.	Main Parts	Describes the main parts of the printer.
4.	Printer Operation	Contains the information on how to set up and operate the printer.
5.	User Interface	Explains how to use the UI to create and save messages.
6.	Maintenance	Contains the information on how to maintain and clean the printer.
7.	Troubleshooting	Contains the operator level diagnostic and troubleshooting procedures.
8.	Appendix A - Specifications	Contains printer specifications.
9.	Glossary	Explains the printer related technical terms

Table 1-3: List of Chapters

Introduction

The policy of Videojet Technologies Inc. is to manufacture non-contact printing/coding systems and ink supplies that meet high standards of performance and reliability. We enforce strict quality control techniques to eliminate potential defects and hazards in our products.

The intended use of the printer is to print information directly onto a product. Use of this equipment in any other fashion may lead to serious personal injury.

The safety guidelines provided in this chapter are intended to educate the operators on all safety issues so that the printer is serviced and operated in a safe manner.

General Safety Guidelines

- Always refer to the correct service manuals as per the specific Videojet printer model for important details.
- Only Videojet-trained personnel must carry out installation and maintenance work. Any such work undertaken by unauthorized personnel may damage the printer and will invalidate the warranty.
- To avoid damage to the printer components, use only soft brushes and lint free cloths for cleaning. Do not use high pressure air, cotton waste, or abrasive materials.
- The printhead must be completely dry before attempting to start the printer, otherwise the printhead may get damaged.
- Do not fit or remove any connector on the printer when the power is turned on, otherwise the printer may get damaged.

Electrical Safety Guidelines

This section explains the safety guidelines related to electrical power supply and electrical cables.

Electrical Power Supply



Warning

PERSONAL INJURY. Lethal voltages are present within this equipment when it is connected to the mains electrical supply. Only trained and authorized personnel must carry out the maintenance work.



Warning

PERSONAL INJURY. Observe all statutory electrical safety codes and practices. Unless it is necessary to run the printer, disconnect the printer from the mains electrical supply before removing the covers or attempting any service or repair activity. Non-adherence to this warning can result in death or personal injury.



Warning

PERSONAL INJURY. A high AC voltage is present at the inverter and backlight. Extreme caution is required when diagnosing failure in these areas.

Electrical Cables



Warning

PERSONAL INJURY. Use only the main power cable supplied with the printer. The end of this cable must have an approved, three-pole, main plug that has a protective ground conductor.

The electrical power cables, sockets and plugs must be kept clean and dry.

For pluggable equipment, the socket-outlet must be installed near the equipment and must be easily accessible.



Warning

PERSONAL INJURY. Always inspect the cables for damage, wear, corrosion, and deterioration. Make all grounding/bonding connections void of areas of paint, ink build-up, and corrosion.

Grounding and Bonding



Warning

PERSONAL INJURY. The printer must be connected to an AC power supply that has a protective ground conductor and must be according to IEC requirements or applicable local regulations.



Warning

PERSONAL INJURY. Do not use the printer if there is any interruption in the protective ground conductor or if the protective ground conductor is disconnected. The failure to follow this warning can cause an electrical shock.



Warning

PERSONAL INJURY. Always ground conductive equipment to an earthing electrode or to the building grounding system with approved cables as per NEC standards in order to drain all potential static discharge. For example, a metal service tray to earth ground.



Warning

PERSONAL INJURY. A resistance reading from the grounded service tray to the equipment chassis or mounting bracket should be 0 to less than 1 ohm. A resistance check should be made using a safe and reliable ohmmeter and should be done on a frequent basis.



Warning

PERSONAL INJURY. The PCBs contain static sensitive devices. A suitably grounded, antistatic wrist strap must be worn when working on or handling PCBs.



Warning

PERSONAL INJURY. Always prevent static discharge from occurring. Use proper Grounding and Bonding methods. Only use Videojet approved metallic service trays and ground cables.



Warning

PERSONAL INJURY. Always bond conductive equipment together with approved cables to maintain them at the same potential and minimize static discharge. For example, printhead to metal service tray.

**Warning**

PERSONAL INJURY. The Optional Wash Station has been *solely* designed for the cleaning of the printhead.

Do not use it for purging or printing operations or for any other purposes.

Always ensure that the jet is stopped and that any hazardous voltages are switched off prior to the commencement of the printhead wash down.

**Caution**

EQUIPMENT DAMAGE. Always empty the service trays frequently. Some inks and cleaning solutions are flammable. Make sure that the waste fluids are disposed according to HAZMAT.

Fuses

**Warning**

PERSONAL INJURY. To ensure continued protection against fire hazards, replace fuses only with the specified type and rating.

Fluid Safety Guidelines

This section describes the hazards that may occur while handling ink, make-up fluid, and cleaning solutions, and the safety precautions that a user must take to prevent the hazards.

Read the Material Safety Data Sheets

Read and understand the *Material Safety Data Sheet (MSDS)* before using any ink, make-up fluid, or cleaning solution. An MSDS exists for each type of ink, make-up fluid, and cleaning solution. For more information, visit www.videojet.com and navigate to *Documentation > Material Safety Data Sheets*.

Ink and Make-up Fluid



Warning

PERSONAL INJURY. The ink and make-up fluid are irritating to the eyes and respiratory system. To prevent personal injury when handling these substances:

Always wear protective clothing and rubber gloves.

Always wear goggles with side-shields or a face mask. It is also advisable to wear safety glasses when carrying out maintenance.

Apply barrier hand cream before handling ink.

If ink or make-up fluid contaminates the skin, wash immediately with soap water. DO NOT use washdown or solvent to clean ink stains from the skin.



Warning

PERSONAL INJURY. The ink and make-up fluid are volatile and highly flammable. They must be stored and handled in accordance with local regulations.

Do not smoke or use a naked flame in the vicinity of these substances.

Immediately after use, remove any tissue or cloth that becomes saturated with these substances. Dispose all such items in accordance with the local regulations.

In the event that any ink or make-up fluid container is not completely empty after use, it should be resealed. Only full bottles are recommended for use when replenishing ink or make-up fluid; partially filled bottles must be disposed in accordance with the local regulations.



Warning

PERSONAL INJURY. When setting up the nozzle, direct the ink stream into a beaker or suitable container. To avoid the contamination of the ink, do not re-use any ink collected in this way. Dispose all waste ink in accordance with the local regulations.

**Warning**

PERSONAL INJURY. Prolonged breathing of make-up fluid or cleaning fluid vapor may cause drowsiness and/or effects similar to alcoholic intoxication. Use only in open, well-ventilated areas.

Cleaning Solution

**Warning**

PERSONAL INJURY. The cleaning solution is poisonous if taken internally. Do not drink. Seek medical attention immediately if ingested.

**Warning**

PERSONAL INJURY. The cleaning solution is irritating to the eyes and respiratory system. To prevent personal injury when handling this substance:

Always wear protective rubber gloves and clothing.

Always wear goggles with side-shields or a face mask. It is also advisable to wear safety glasses when carrying out maintenance.

Apply barrier hand cream before handling ink.

If cleaning solution contaminates the skin, rinse off with running water for at least 15 minutes.

**Warning**

PERSONAL INJURY. The cleaning solution is volatile and highly flammable. It must be stored and handled in accordance with local regulations.

Do not smoke or use a naked flame in the vicinity of the cleaning solution.

Immediately after use remove any tissue or cloths that become saturated with cleaning solution. Dispose all such items in accordance with local regulations.



Caution

EQUIPMENT DAMAGE. Ensure that the cleaning solution is compatible with the ink used before carrying out printhead cleaning otherwise the printhead may get damaged.



Caution

EQUIPMENT DAMAGE. Any cleaning solutions containing either chloride, including hypochlorite bleaches or hydrochloric acid, can cause unacceptable surface pitting and staining. These should not be used in contact with stainless steels. If wire brushes or wire scouring pads are used, these should be made of stainless steel. Make sure that any abrasive media used is free from sources of contamination, especially iron and chlorides.

Compressed Air Safety Guidelines



Warning

PERSONAL INJURY. Airborne particles and substances are a health hazard. Do not use high pressure compressed air for cleaning purposes.

UI Related Safety Guidelines



Caution

DATA SECURITY. To prevent unauthorized access to the software, ensure that **Logout** is selected (HOME page) when exiting from a higher level password.

**Caution**

RISK OF DATA LOSS. Ensure the correct message name is selected for message deletion. All messages apart from the TEST MESSAGE will be deleted when you select all for Delete.

Other Important Guidelines

**Caution**

EQUIPMENT DAMAGE. After a Quick Stop, the machine should not be left in this state for any length of time as drying ink may make restarting difficult.

**Caution**

EQUIPMENT DAMAGE. The printhead must be completely dry before attempting to start the printer otherwise the EHT will trip.

**Warning**

PERSONAL INJURY. If the battery is replaced by an incorrect type, it will lead to an explosion. Always dispose off the used batteries according to the instructions and local regulations.



Warning

PERSONAL INJURY. In a fault condition, heater can reach 70 °C. Do not touch the plate on which the heater is mounted. The failure to follow this warning can cause personal injury.



Caution

EQUIPMENT DAMAGE. If the jet is on and no warnings are present, touching the status bar will start the print. When you are viewing the warning messages, make sure that the print mode is not activated in error.

Videojet 1560 Printer

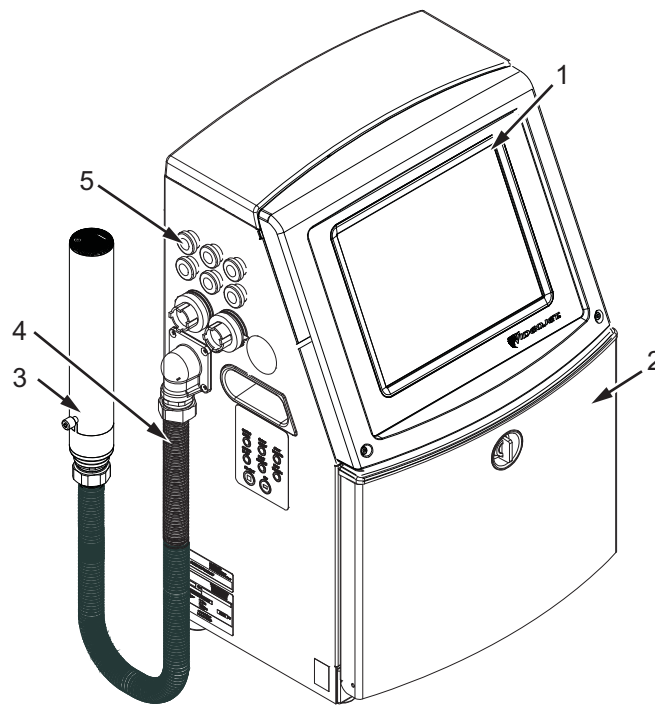

- | | |
|--------------------|-----------------------------|
| 1. Control Panel | 5. Connector Panel |
| 2. Ink Compartment | 6. Electronics Compartment* |
| 3. Printhead | 7. Main Power Switch* |
| 4. Umbilical | 8. Back Filter* |

*The components are not shown in the picture.

Figure 3-1: Main Parts of the Printer

Home Page

You can use the home page (Figure 3-2 on page 3-3) to do the following tasks:

- Start and stop the printer
- CreateSelect, view and edit the print messages
- Monitor the status of the printer and consumables
- Navigate to the printer functions

The home page displays the following information:

- The printer status, fault conditions and the counters.

Note: When the batch counter option is enabled, the screen displays the batch counter.

- The name and the content of the message. The content in the display is an accurate representation of what the printer prints on the product (WYSIWYG).
- The icons that indicate the fluid levels in the ink and make-up fluid cartridges.

For more information on the home page and the use of the bars and buttons, refer “Getting started with the User Interface” on page 4-2.



Figure 3-2: Home Page

Tools Page

Touch the *Tools* button on the home screen to access the *Tools* page (Figure 3-3).



Figure 3-3: Tools Page

The tools page allows you to access the following pages:

- Setup page: Permits you to set up the printer.
- Diagnostics page: Provides on-line fault finding routines and diagnostic functions.
- Databases page: Provides control over the message database of the printer, including transfer of messages.
- Message Editor page: Permits you to create and edit messages.

Electronics Compartment

The electronics compartment contains the parts shown in Figure 3-4.

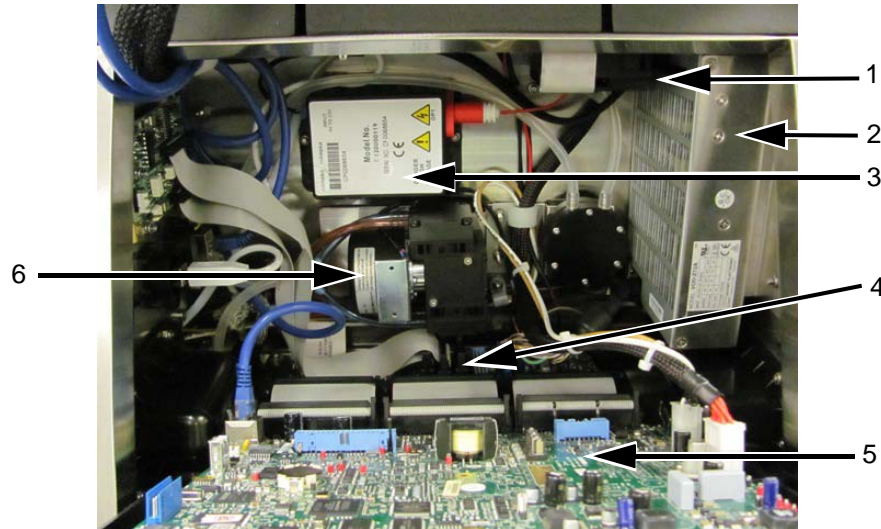

- | | |
|--------------------------------------|----------------------------------|
| 1. Electronics Compartment Fan | 4. Printer Interface Board (PIB) |
| 2. Power Supply Unit | 5. Control System Board |
| 3. Extra High Tension (EHT/HV) Block | 6. Positive Air Pump Block |

Figure 3-4: Electronics Compartment

Note: When a customer orders a Videojet 1560 printer with an air dryer, the positive air pump is removed from the printer. The air dryer supplies positive air to the printhead from an external air source. Air dryers are required when the printer is operated in an environment with elevated humidity or where certain water sensitive inks are used. Please contact Videojet Technologies Inc. at 1-800-843-3610 (for all customers within the United States). Outside the U.S., customers should contact their Videojet Technologies Inc. distributor or subsidiary for assistance.

Ink Compartment

The ink compartment of the printer contains the ink core module, and the smart ink and make-up fluid cartridges. The cooling fan cools the ink compartment and a filter does not allow the dust into the ink compartment.

Ink Core Module

The ink core module maintains the pressure and viscosity of the ink in the printer, and contains the following parts:

- Ink Module
- Ink Pump

Note: The ink core module comes as a single unit. You cannot remove or replace any part inside the ink core module except the ink pump.

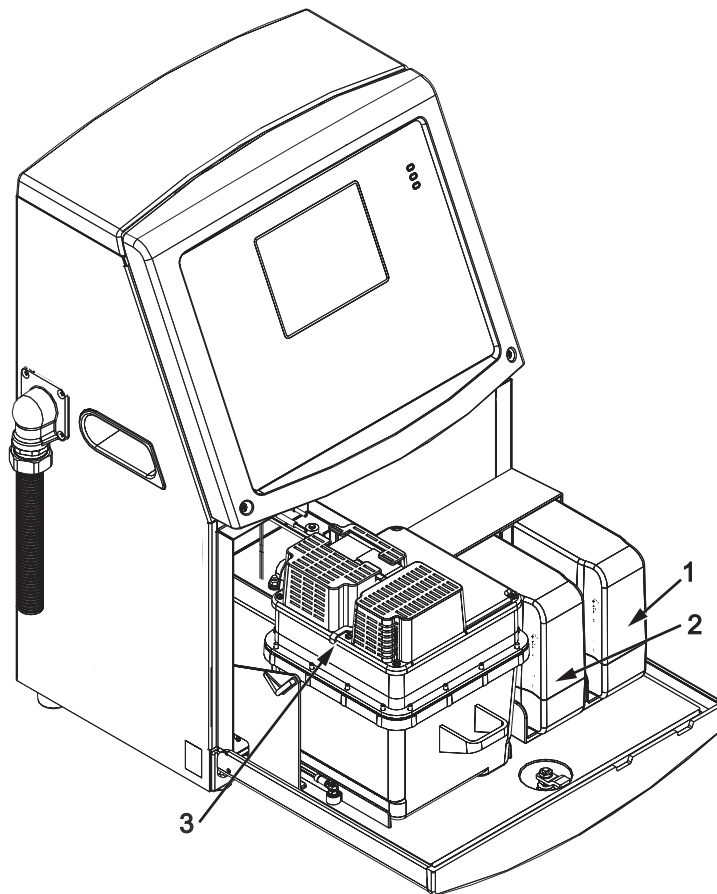

- | | |
|----------------------------|-------------------------|
| 1. Ink Cartridge | 4. Ink Compartment Fan* |
| 2. Make-up fluid Cartridge | 5. Gutter Pump* |
| 3. Ink Core Module | |

*The components are not shown in the picture.

Figure 3-5: Ink Compartment

Smart Cartridge

Note: Refer to “Replace Smart Cartridges” on page 6-4 to replace the cartridges.

The smart cartridges use the smart chip technology to ensure the proper and in shelf-life ink and make-up fluids are used.

Ink Compartment Fan

The ink compartment fan cools the ink module and the ink pump.

Printhead and Umbilical

The printhead uses the ink supplied by the ink core module to print the text and graphic characters on a product. The control signals and ink are sent to the printhead through the umbilical.

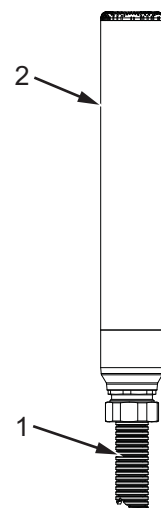

- 1. Umbilical
- 2. Printhead

Figure 3-6: Printhead and Umbilical

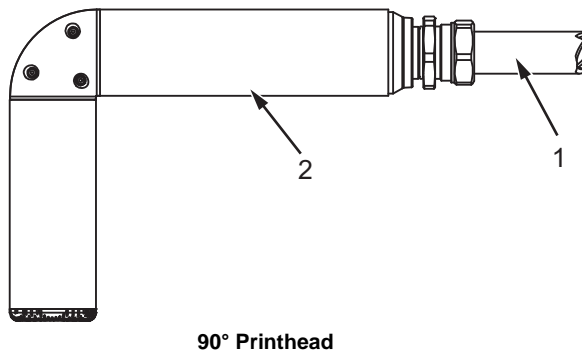

- 1. Umbilical
- 2. Printhead

Figure 3-7: Printhead and Umbilical

Connector Panel

The connector panel is on the left side of the printer (item 5, Figure 3-1 on page 3-1). The panel contains the connectors shown in Figure 3-8 on page 3-9.

Note: The number of connectors provided depends on the model you select.

Table 3-1 provides the connectors for the printer.

Connector Type	PCB	Standard	Optional
Print Trigger 1	PCB 1	Videojet 1560	-
COMMS RS232	PCB 2	Videojet 1560	-
COMMS RS485	PCB 1	Not Available on Videojet 1560	
Shaft Encoder	PCB 2	Videojet 1560	-
Relay Switches	PCB 1	Videojet 1560	-
Status Output (Lampstack)	PCB 2	Videojet 1560	-
USB	-	Videojet 1560	-
Ethernet	-	Videojet 1560	-

Table 3-1: Connector Panel Ports

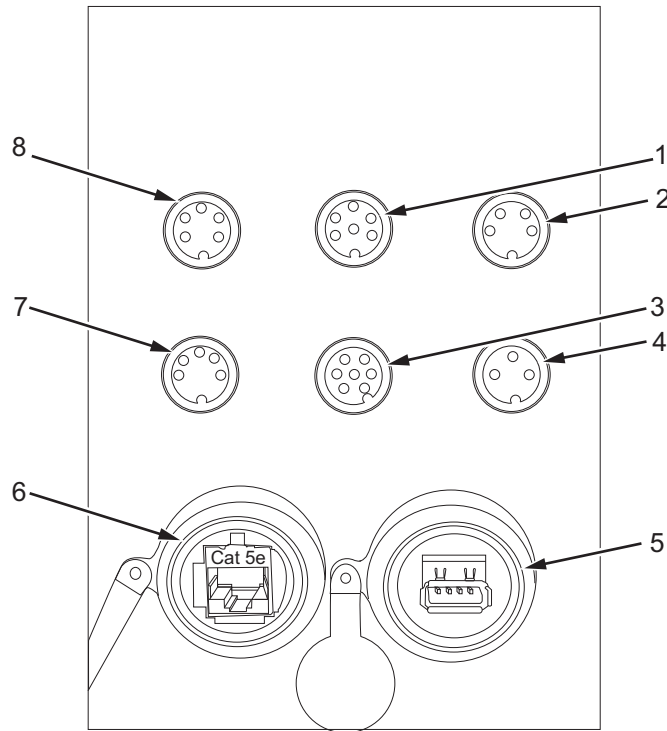

- | | |
|-------------------------------------|-----------------------|
| 1. Status Output (Lampstack) | 5. USB |
| 2. Shaft Encoder | 6. Ethernet |
| 3. Relay Switches | 7. COMMS RS485 |
| 4. Print Trigger 1 | 8. COMMS RS232 |

Figure 3-8: Connector Panel

Note: COMMS RS485 is not available on Videojet 1560.

Pinout Information

Connector	Pinout
Status Output (Lampstack)	DIN 6 Pin
Shaft Encoder	DIN 4 Pin
Relay Switches	DIN 7 Pin
Print Trigger 1	DIN 3 Pin
USB	-
Ethernet	-
COMMS RS485 (180° Pin Position)	DIN 5 Pin
COMMS RS232	DIN 5 Pin

Table 3-2: Connector Pinout Information

Main Power Switch

The main power switch (item 1, Figure 3-9) is a green push button to turn the printer on and off. You can find the main power switch on the right side of the printer.

Note: The handles (item 2) are provided for easy movement of the unit.

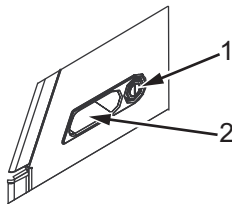

- 1. Main Power Switch
- 2. Handles

Figure 3-9: Main Power Switch

Back Filter

The ink compartment fan draws the air from the outside atmosphere to keep the ink compartment cool. The back filter removes the dust from the air that goes inside the ink compartment. IP55 back filter is standard for Videojet 1560.

The IP65 back filter is optional for Videojet 1560.

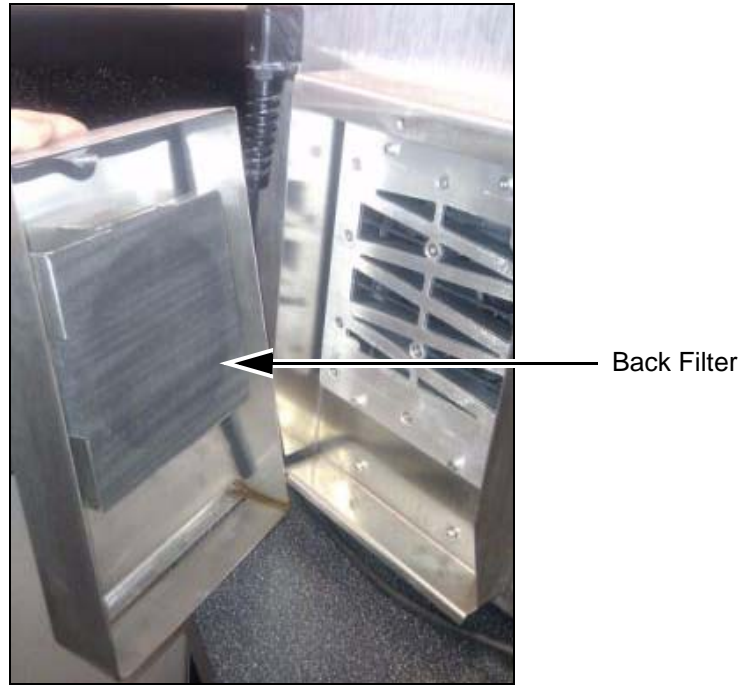

Figure 3-10: Back Filter (IP55 Version)

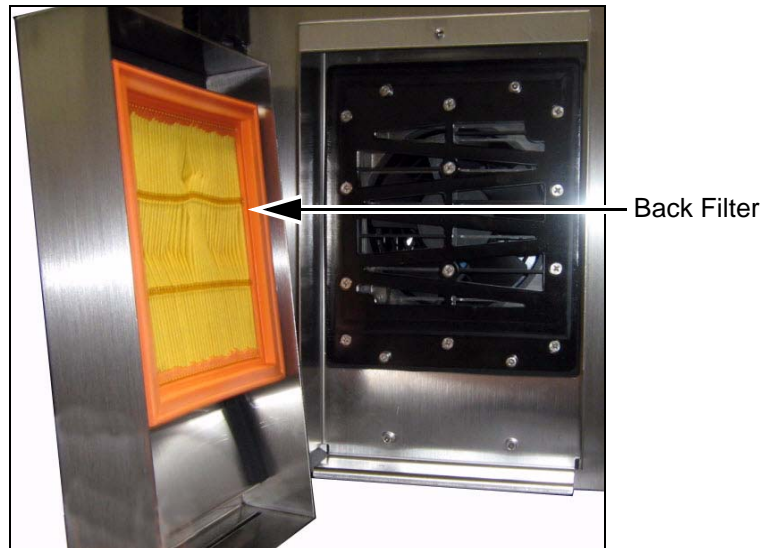

Figure 3-11: Back Filter (IP65 Version)

Introduction

This chapter provides the procedures to do the following tasks:

- Turn on the printer
- Getting started with the User Interface
- Using the Tools Page
- Clean/Quick start and stop the printer
- Set the passwords
- Counters
- Run hours
- Enter service information
- Printer configuration
- Print the messages
- Turn off the printer

How to Turn on the Printer

Do the following tasks to turn on the printer:

- 1 Do the visual inspection.
- 2 Make sure that the electrical supply for the printer is available.
- 3 Press the main power switch to turn on the printer.
- 4 Wait for the printer operator control system to boot up.

Getting started with the User Interface

The User Interface is an icon-based operator control system. It has an easy-to-use touch screen and most areas of the display are active, that is, touching an area on the screen is like pressing a button on a traditional control panel. All technical aspects of the printer setup and control are accessed through the Tools button.

Figure 4-1 shows the home page of the operator control system.

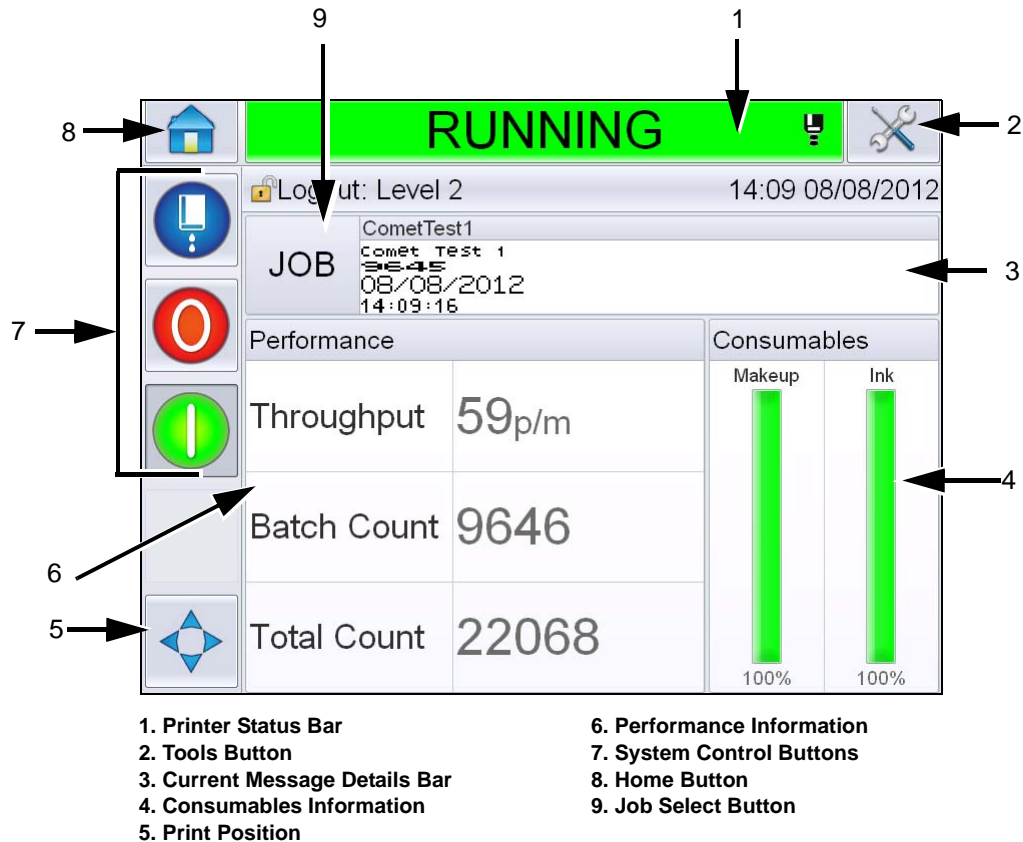

Figure 4-1: Home Page

Note : The user can change the language of the user interface. For more information, refer “Internationalisation” on page 5-7 of Table 5-3.

The *Home* page allows the user to access the following information:



Warning

PERSONAL INJURY. The printer starts printing if you touch the printer status bar when the printer is in *OFFLINE mode*. Make sure that you do not touch the status bar if the printer is not required to run.

Buttons	Information
Printer Status Bar	Provides information about the status of the printer: <ul style="list-style-type: none"> • <i>Running</i>- if printer on and jet on and, printing. • <i>Offline</i>- if printer on and jet on and, not printing. • <i>Shutdown</i>- if printer is powered on and jet off. •  - Provides information whether the jet is on, off or starting up. • Allows the user to enable/disable printing as requested.
Tools Button	Permits the user to access the Tools page.
Current Message Details Bar	Displays the actual message being printed and also permits the user to edit the current message.
Consumables Information	Provides information about the status of make-up and ink cartridges levels.
Print Position	Allows the user to enter the Width and Product Delay in Linear units or Divider Strokes and also to enable or disable Reverse Printing and Invert Printing options.
Performance Information	Provides information about the number of jobs produced in a batch, total number of individual jobs printed and the speed at which the job is printed. It shows the Printer and Operational Availability and other detailed information such as short term and long term efficiencies, Trend speed, trend efficiency and nominal speed.

Table 4-1: Home Page

Buttons	Information
Control Buttons	<p>Permits the user to perform the following actions:</p> <ul style="list-style-type: none"> • Clean/Quick Start or Clean/Quick Stop the Jet. • Disable (Stop) the print mode. • Enable (Run) the print mode. <div data-bbox="805 411 1096 720" style="display: flex; align-items: center;">  <div style="margin-left: 10px;"> <p>Jet Start/ Stop</p> <p>Stop</p> <p>Run (Print)</p> </div> </div> <p style="text-align: center;"><i>Figure 4-2: Control Buttons</i></p> <p>Note: Control buttons are visible on each page. Jet button is always visible while Run and Stop buttons are visible when the printer is switched on.</p>
Home Button	Permits the user to access the Home screen as shown in Figure 4-1 on page 4-2.
Job Select Button	Permits the user to select the required job from the list.

Table 4-1: Home Page (Continued)

Using the Tools Page

Touch the *Tools* button on the home page to access the tools page (Figure 4-3).



Figure 4-3: Tools Page

The *Tools* page allows the user to access the following pages:

- Setup Page: Permits the user to modify the printer setup parameters
- Diagnostics Page: Provides on-line fault finding routines and diagnostic functions
- Databases page: Provides control over the jobs database of the printer.
- Message Editor Page: Permits the user to edit the message details.

How to Clean/Quick Start and Stop the Printer

The default procedures to start and stop the printer are Clean Start and the Clean Stop.

***Note:** If the Clean Start or the Clean Stop are not available, the printer requires a Quick Start or Quick Stop. The printer cannot provide the Clean Start and the Clean Stop options if the make-up fluid is empty or if the ink core level is high. Make sure that the make-up fluid is not empty or the ink core level is not high.*



Caution

EQUIPMENT DAMAGE. Do not perform the Clean Start or the Clean Stop many times. The failure to follow this caution can cause high use of flush and dilution of the ink. The diluted ink decreases the quality of the print.

How to Clean/Quick Start

Touch the *Jet* button on the home page. *Clean Start Jet* is selected. If *Quick Start Jet* is required, continue to hold the button so that both options are displayed and slide your finger over quick start to select. The printer status bar flashes and displays 'Starting Jet'. The printer then goes to *OFFLINE* mode.

How to Clean/Quick Stop

Touch the *Jet* button on the home page. *Clean Stop Jet* is selected. If *Quick Stop Jet* is required, continue to hold the button so that both options are displayed and slide your finger over quick start to select. The printer stops the flow of ink. The printer status bar flashes and displays 'Stopping Jet' and goes to *SHUTDOWN* mode.

How to Set the Passwords

The UI has the following access levels:

- The level 0 is the default password level.
- The levels 1 and 2 are password protected. The customer can configure the two levels. The customer can use the two levels to access different menus in the UI.

The passwords are set and configured through CLARiTY[®] configuration manager. Refer to the Service Manual for reference.

The UI has the following access levels:

- Level 1
- Level 2
- Manufacturer



Figure 4-4: Password Levels

How to Login

When a menu requires the user to be logged in above Level 0, the user will be prompted to select the required password level.



Figure 4-5: Select Level

Login at level 1 (default password = 1111) or level 2 (default password = 2222) password. The current password level changes to selected password level from level 0.

Where access requires a higher password level, the user must first logout and then login at the required password level.

Only those functions available at the logged in password level will be visible to the user. If there are no options available to the user at that password level, a message will be displayed.

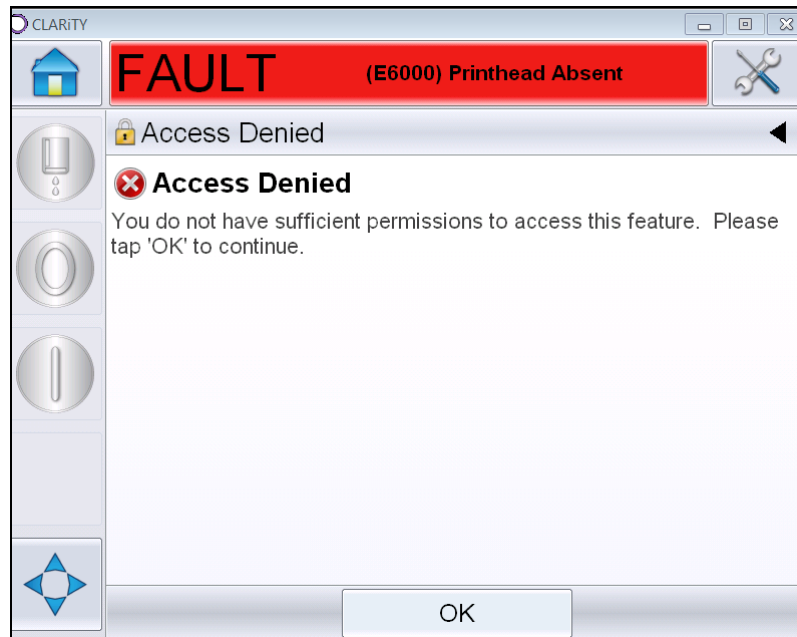
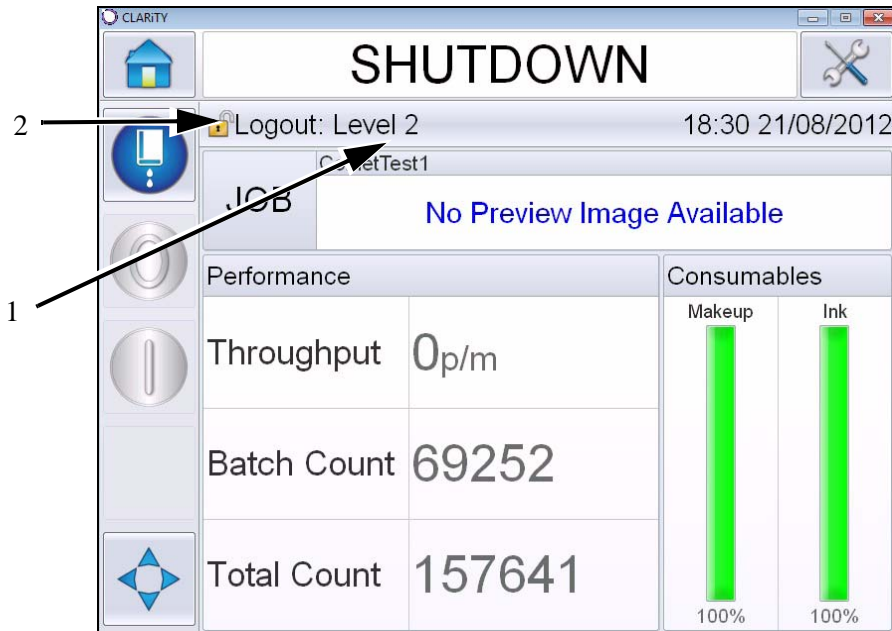

Figure 4-6: Access Denied

How to clear password

Go to home page and touch *Logout* (see Figure 4-7 on page 4-10). You will be able to logout from the level currently active.

Note: *Level 1 and Level 2 passwords will automatically logout after a default period of time. This feature can be configured in the CLARiTY[®] Configuration Manager.*



- 1. Current Password Level
- 2. Touch to logout

Figure 4-7: Logout

Counters

The home page counter shows the total number of products that the printer has detected. All detected products are counted here including the products on which the printer has not printed a message.

How to Reset the Counters

Do the following task to reset the counter:

Navigate to *Tools > Setup > Consumables* and select the required reset operation.

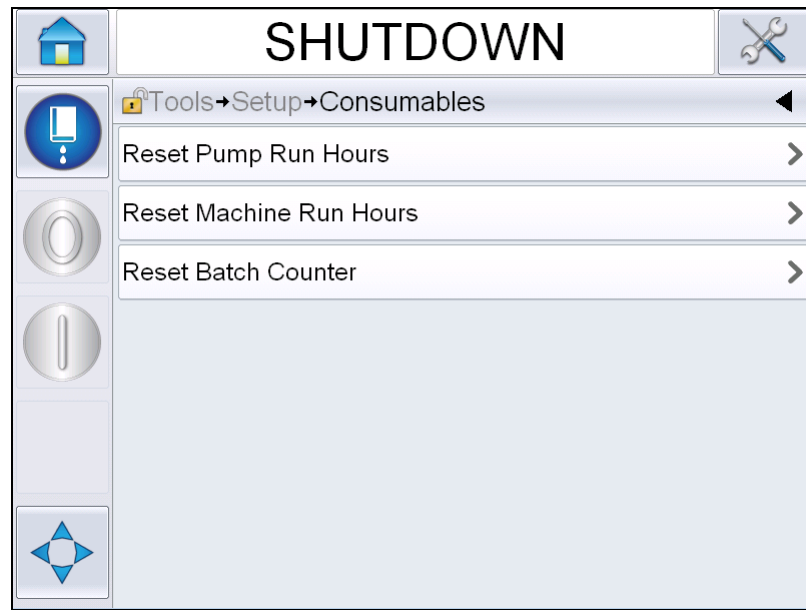

Figure 4-8: Reset Counters

Note: Once you reset the counter, you cannot undo the operation.

Run Hours

How to View Run Hours

You can see the number of hours that the printer and ink pump have run. Navigate to *Tools > Diagnostics > Consumables > Printer Life*.

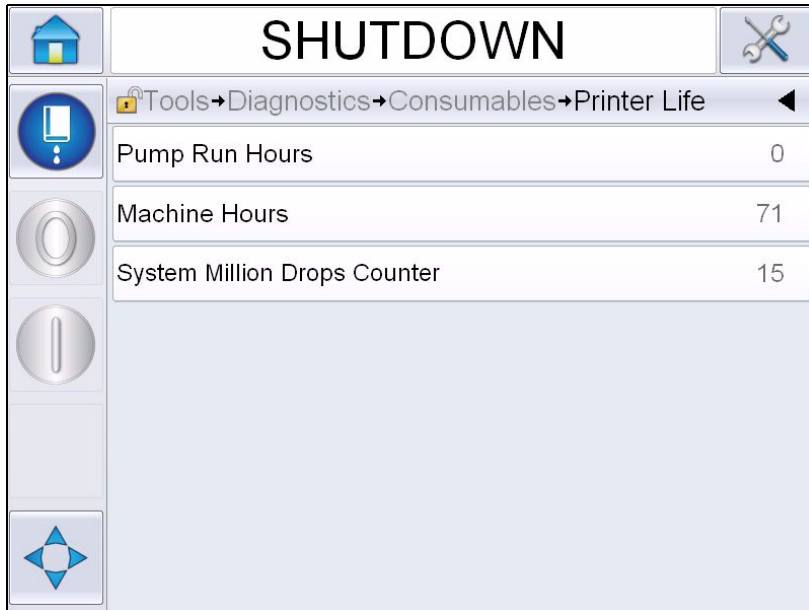

Figure 4-9: View Run Hours

How to Reset Run Hours

Navigate to *Tools > Setup > Consumables* and select *Reset Pump Run Hours* or *Reset Machine Run Hours* as required.



Figure 4-10: Reset Run Hours

How to Configure the Serial Port

The RS-232 serial communication port is standard for Videojet 1560 printer. For more information, contact the Videojet distributor or subsidiary.

You can prepare the printer communication port for the transmission of data logging information between the port and a remote device.

- 1 Navigate to *Tools > Setup > Control > Communications*.



Figure 4-11: Serial Port

2 Select RS232 port.

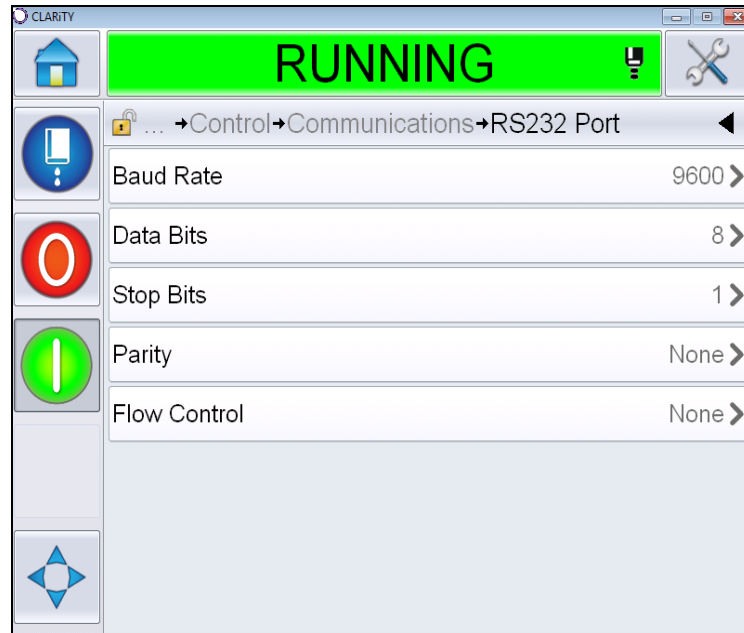

Figure 4-12: Serial Port

3 You can configure the following settings:

Baud Rate	Sets the baud rate for transmission to remote devices
Data Bits	Sets the number of bits used in a data word
Stop bits	Sets the number of stop bits used in a data word
Parity	Select Odd parity, Even parity or None parity for error detection within data transmission
Flow Control	Select None, Software or Hardware for flow control.

4 Touch *OK* after configuring each option. Touch the back button or home button to complete the configuration.

How to Enter Service Information

You can record the service information on the printer.

- 1 Navigate to *Tools > Setup > Control > Contact Information*.

Figure 4-13: Enter Service Information

- 2 Enter the following information in the fields:

Field	Entry
Printer Location	Correct name of the location (For example, factory name and machine number).
Customer Name	The name of your company.
Address Lines 1 to 4	Complete postal address of the printer location.
Serial Number	Enter the serial number of the printer.
Telephone Number	The full telephone number of Videojet Technologies Inc. Customer Service Department is 1-800-843-3610 (United States only), or the local Videojet Technologies Inc. representative.

- 3 Touch *OK* after entering each information. Touch the back button or home button after entering the information.

Note : You can view the service information by navigating to *Tools > Diagnostics > Consumables > Contact Information*.

Printer Configuration

To configure the printer, navigate to *Tools > Setup > Printhead*.

Note: *The User Interface displays only the options available for selection.*

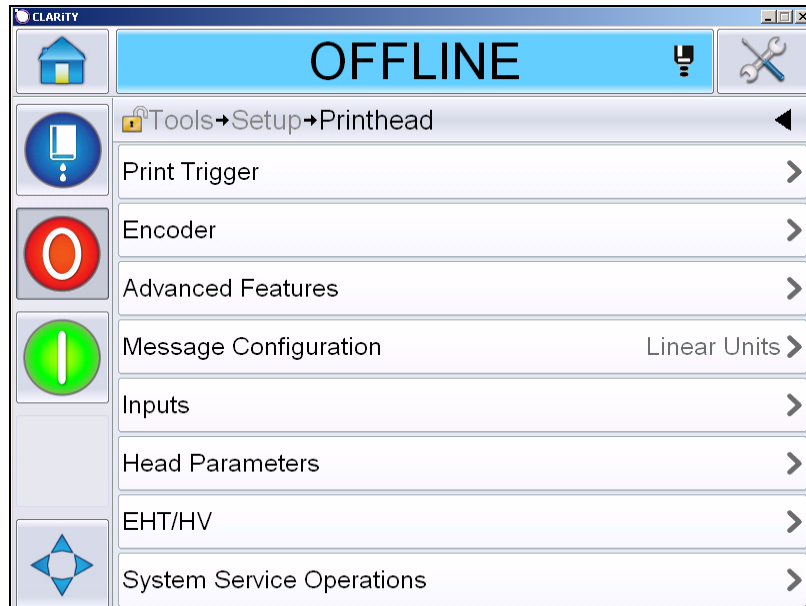

Figure 4-14: Printhead Menu

The printhead menu has the following options:

Print Trigger

Table 4-2 on page 4-18 describes the options in the *Print Trigger* menu.

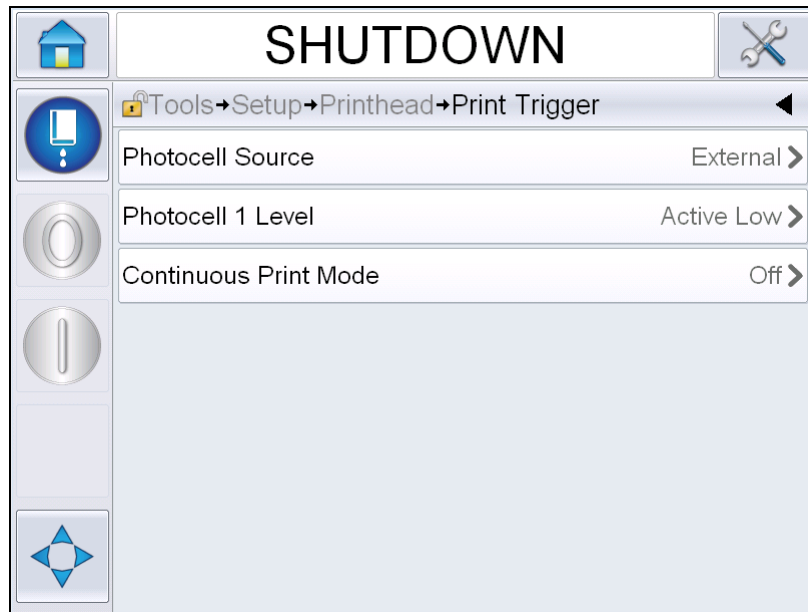

Figure 4-15: Print Trigger Menu

Photocell Source	The print is activated from the source 'External' Note: An option of <i>None</i> is also available in the <i>Photocell Source</i> field.
Photocell 1 Level	Enables the photocell trigger level to be set to high or low.
Continuous Print Mode	Switch on the continuous print option to print the message repeatedly (For more information, refer "How to Use Continuous Print Option" on page 4-27).

Table 4-2: Print Trigger Menu

Encoder

Table 4-3 describes the options in the *Encoder* menu.

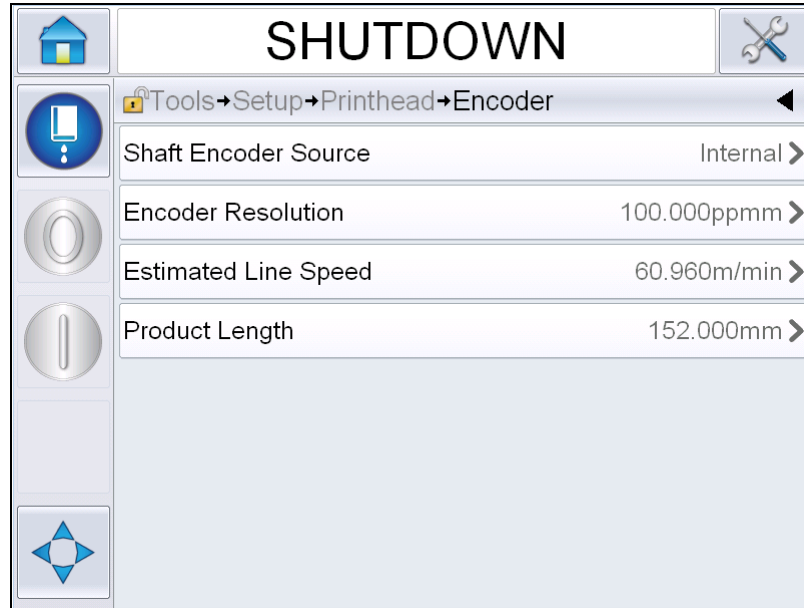

Figure 4-16: Encoder Menu

Note: Setting Shaft Encoder Source to external or auto encoder, will enable Encoder Type menu

Shaft Encoder Source	Set the shaft encoder to Internal option for a fixed line speed. Set to External option for use with a compatible shaft encoder where the line speed is variable. Note: If external shaft encoder is selected, the user has to also enter the encoder type. Set to Auto Encoder for use when speed of the product changes, because the product slips on the conveyor.
Encoder Type	If external shaft encoder is selected, enter the encoder type (non-quadrature, A then B, or B then A).
Encoder Resolution	Enter the encoder resolution.
Estimated Line Speed	Enter the estimated line speed.
Product Length	Enter the product length. Product length is required if Media Width Filtering is set to on. Refer Table 4-4 on page 4-20 for more information on media width filtering.

Table 4-3: Encoder Menu

Advanced Features

Table 4-4 describes the options in the *Advanced Features* menu.



Figure 4-17: Advanced Features Menu

Note: Selecting certain features will disable other features and will remove them from the user interface. For example, setting 'Double Buffering' to 'On' will disable 'Special Printing Mode'. If you are unable to select the required option please review the printer settings.

<p>Double Buffering</p>	<p>The double buffering setting is OFF by default. Enable double buffering to print without product delay. Disable double buffering if an external host controls the printing to prevent print delay.</p> <p>Disable this feature during the following modes: Special Print mode, External Message Select and Auto Encoder.</p> <p>Note: When double buffering is off, delay is needed to build image. Print warnings should be enabled to aid in printer setup.</p>
<p>Media Width Filtering</p>	<p>You can switch this option On or Off.</p> <p>Media Width Filtering sets the product length in the printer. It allows the printer to ignore the product detect trigger whilst the product is passing the photocell. This setting is useful if the photocell would be triggered twice by the same product.</p>

Table 4-4: Advanced Features Menu

Auto Print On Jet	You can enable the machine start printing when the ink jet has started. Note: A message must be available for printing.
Auto Print on Select	Enables the machine to be set up so that it will initiate printing as soon as a message has been selected subject to the ink jet having started.
No Code No Run	You can switch this option <i>On</i> or <i>Off</i> . Note: When the No Code No Run is set to 'On', you have to enter the 'No code No Run Threshold'. Enter the minimum, maximum and default threshold values.
Special Printing Mode	Select DIN printing or Traverse printing mode. You can also switch off the special printing mode.(Refer "DIN Print" on page 4-28) Note: This option is not available when the double buffering is set to ON.
Reversed Product Delay	This option is available if Traverse printing mode is selected. The reversed product delay can be entered in either mm or strokes depending on the unit selected in the message configuration menu.
Photocell 2 Level	To allow the use of both High and Low activating photocells, this command enables the photocell trigger level to be set to high or low.
Remote Source Action	Provides instructions to the printer when the record buffer runs out of data. <i>Stop-</i> the printer will stop the print when it reaches the end of the buffer <i>Repeat Last Value-</i> The printer will continue to print the last message when it reaches the end of the buffer.

Table 4-4: Advanced Features Menu (Continued)

Print Acknowledgement

Table 4-5 describes the options in the *Print Acknowledgement* menu.

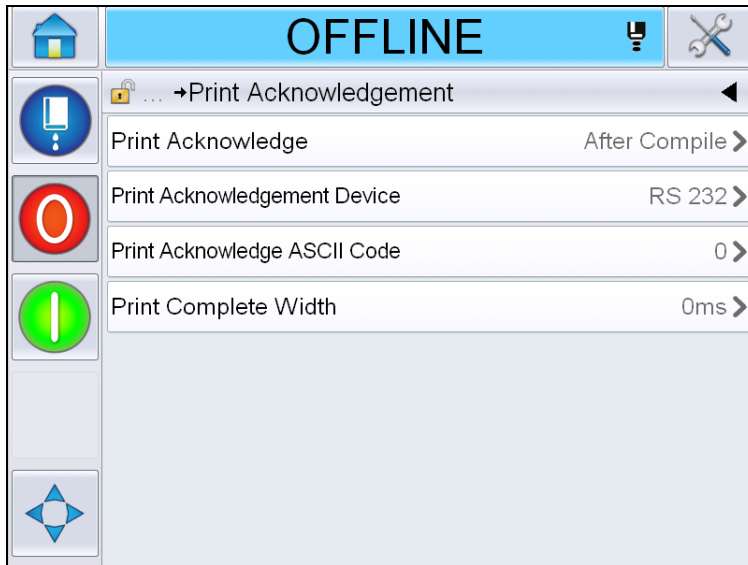

Figure 4-18: *Print Acknowledgement Menu*

Print Acknowledge	Sends a signal to an external control system (normally through the connector COMM1).
	1. Off
	2. After Compile
	Note: When After Compile is turned on, the UI prompts for the Print Acknowledgement Device and Print Acknowledge ASCII code.
Print Acknowledgement Device	Select RS 282 (RS 485 is not available on Videojet 1560).
Print Acknowledge ASCII code	Sets the ASCII character code (0 to 255) sent to the control system.
Print Complete width	Enter the print complete width in meters.

Table 4-5: *Print Acknowledgement Menu*

Message Configuration

The user can select either Linear (mm/inches) or Divider strokes units for configuring the messages in this menu.

Note: Selecting the unit here will change the range of values of the other message parameters into the selected unit

Inputs

Table 4-6 describes the options in the *Inputs* menu.

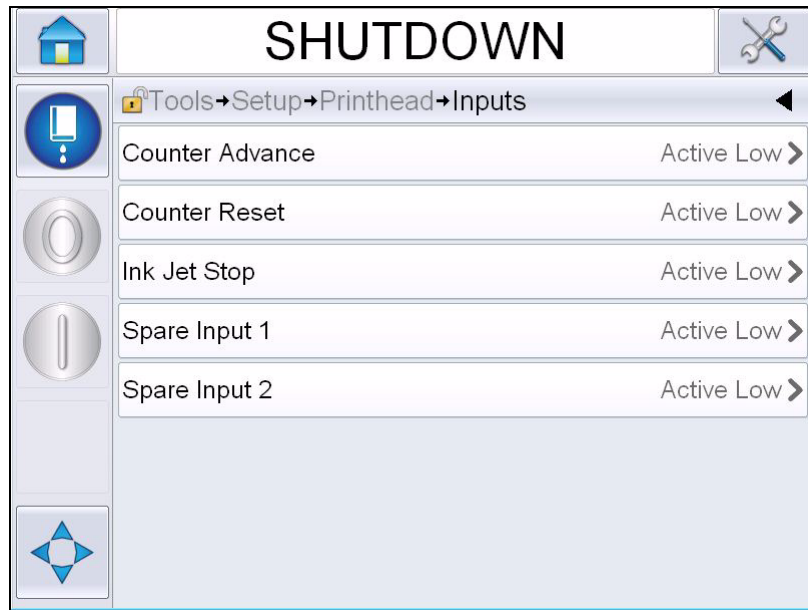

Figure 4-19: Inputs Menu

Counter Advance	Select <i>Active Low</i> or <i>Active High</i> from the options.
Counter Reset	
Ink Jet Stop	
Spare Input 1	
Spare Input 2	

Table 4-6: Inputs Menu

Head Parameters

Table 4-7 describes the options in the *Head Parameters* menu.

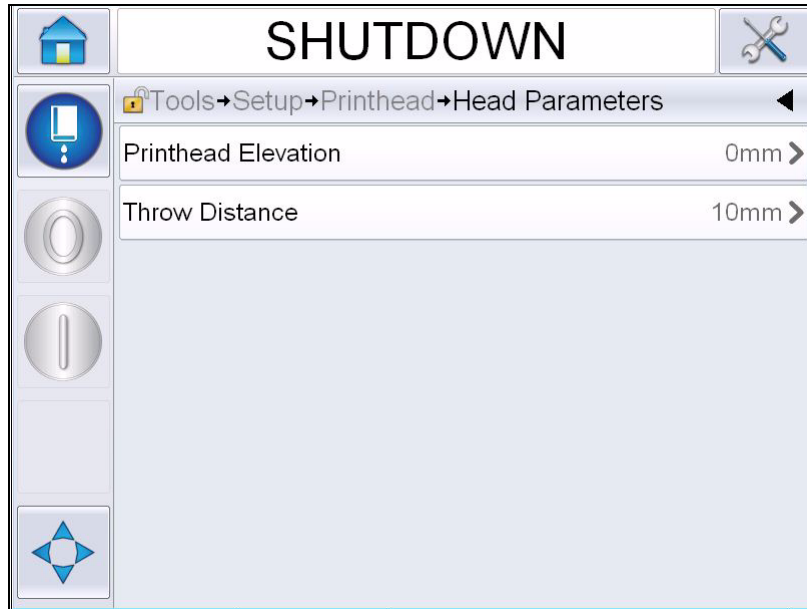

Figure 4-20: Head Parameters Menu

Printhead Elevation	Enter the printhead elevation in millimeters. It is the vertical distance between the umbilical exit point on the side of the cabinet and the bottom of the printhead when it is fitted to the conveyor for production printing. This parameter is setup during installation and need not be adjusted unless installation has changed.
Throw Distance	Enter the distance that is set between the printhead and the product in millimeters.

Table 4-7: Head Parameters Menu

EHT/HV

Table 4-8 describes the options in the *EHT/HV* menu.

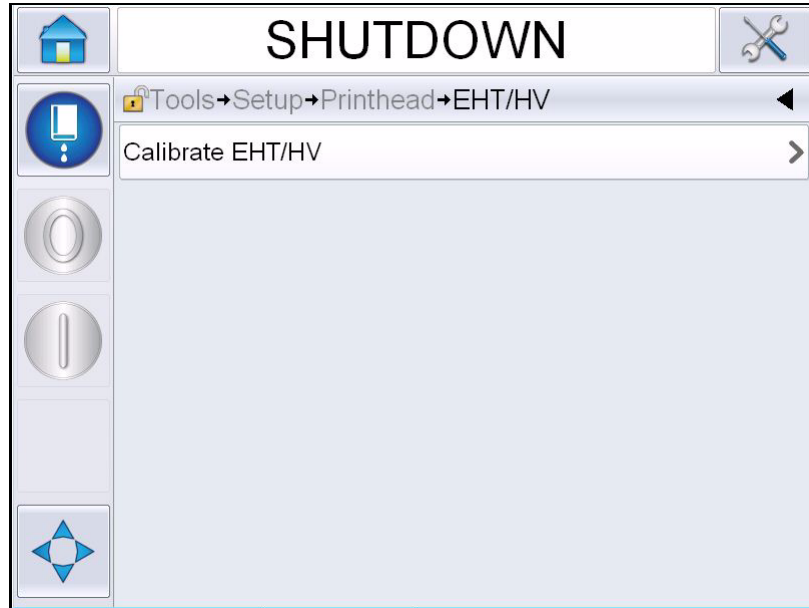

Figure 4-21: EHT/HV Menu

Calibrate EHT/HV	Follow on-screen commands to calibrate EHT/HV. EHT/HV calibration is done during installation and should only be carried out when directed.
------------------	---

Table 4-8: EHT/HV Menu

System Service Operations

Table 4-9 describes the options in the *System Service Operations* menu.

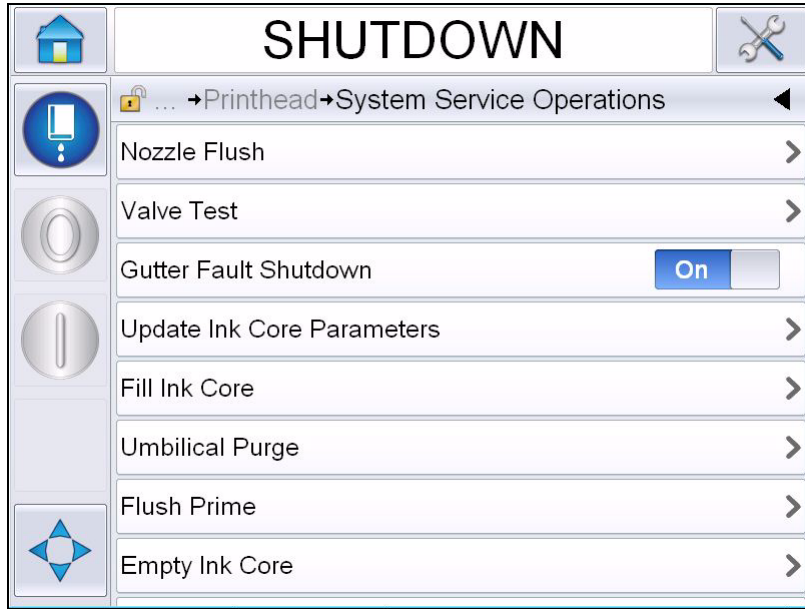

Figure 4-22: System Service Operations Menu

Nozzle Flush	Use this option to flush the nozzle. The system asks for a confirmation before proceeding.
Valve Test	Use this option to conduct the valve test. The user can select the valves then the test type. Note: This option is available only when the printer is in shutdown state.
Gutter Fault Shutdown	You can either Switch On or Switch Off the option.
Update Ink Core Parameters	Use this function to update the ink core parameters.
Fill Ink Core	This function is used to fill an empty ink core module by adding ink from the Ink cartridge. Usually this function is used during commissioning or ink core module replacement. Refer the service manual for more information.
Umbilical Purge	When using Umbilical Purge, the umbilical feed and return tubes must be disconnected from the nozzle feed and return tubes. Loop the umbilical feed and return tubes together and cap the nozzle feed and return tubes. Refer the service manual for more information.

Table 4-9: System Service Operations Menu

Flush Prime	The UI asks for a confirmation before proceeding. Refer service manual for more information.
Empty Ink Core	This function empties the ink from the ink core module and puts the ink in a specially programmed ink cartridge
Flush Ink Core	Flushing of the ink core will take place. Flush Ink core is performed if the printer is shipped into another location or going for some storage. Follow the screen prompts.

Table 4-9: System Service Operations Menu (Continued)

Note: The options available in the Setup menu depends on the printer setup.

How to Use Continuous Print Option

If you enable the *Continuous Print* (Figure 4-15 on page 4-18) mode, the message is printed repeatedly. The message is printed only if the input of product detect is enabled. This option is useful when you print the messages at correct and regular intervals of time for continuous products.

- 1 Select *Continuous Print* from the *Print Trigger Menu*. The *Continuous Print* dialog box appears (see Figure 4-23).

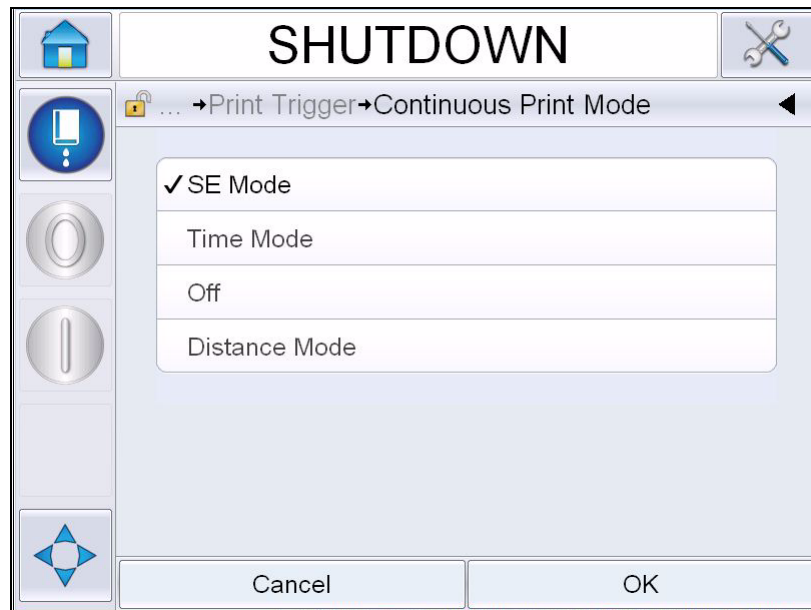

Figure 4-23: Continuous Print Dialog Box

- 2 Set the *SE Mode* delay to use external shaft encoder pulses to set the distance between the start of each print. Enter the minimum, maximum and default values of SE Pulses.

- 3 If there is no external shaft encoder, set *Time Mode* delay to use the pulses internally created to set the distance between each print. Enter the minimum, maximum and default values of Time Delay.
- 4 Set Distance Mode delay to use a user defined distance interval to set the gap between the start of each print.

Note: If in external encoding, correct PPI or PPMM settings must be entered in the line configuration menu for the printer to calculate correct repeat distance.

DIN Print

Navigate to *Tools > Setup > Printhead > Advanced Features > Special Printing Mode* and select *DIN Printing*.

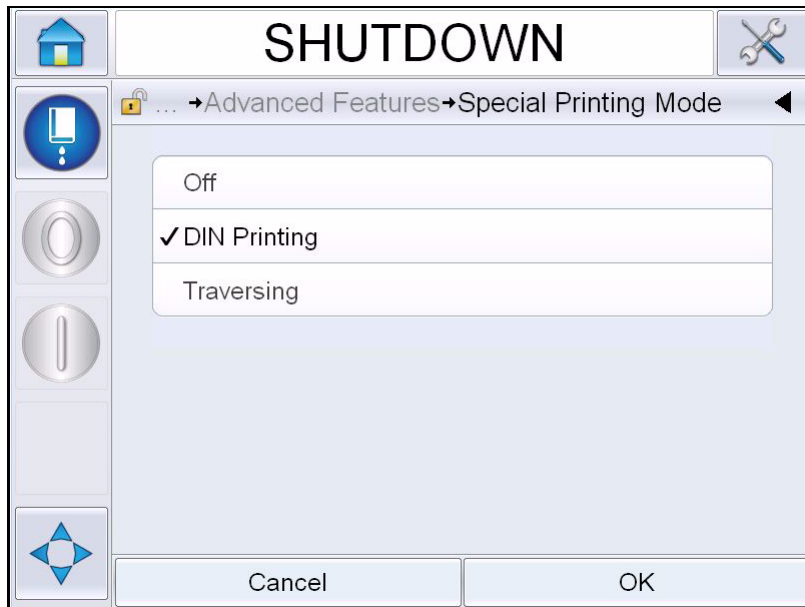

Figure 4-24: Continuous Print Dialog Box

DIN Printing	Automatically reverses every other print. This method is used when printing on cables.
Traversing Printing	Configures the message to allow printing in bi-directional print

How to Print Messages

You must select a message before you start the printing process.

How to Select a Message

If you want to print a message that is not displayed as the current message, you can select a different one.

To select a message, proceed as follows:

- 1 Touch the *Job* button on the home screen.
- 2 A list of available messages appears (see Figure 4-25).

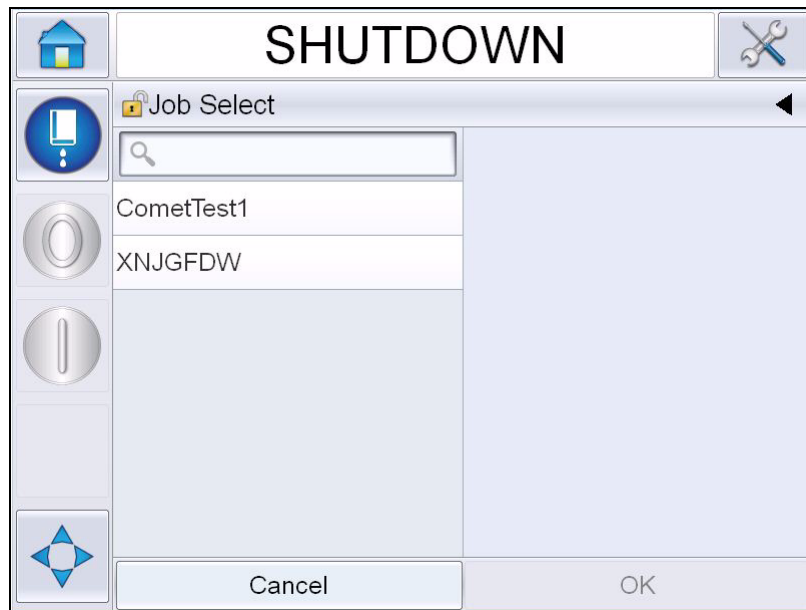

Figure 4-25: Job Select

- 3 Touch the name of the required message in the list. If the list is long, a “scroll bar” appears to the right of the list. Drag the scroll bar up or down to move through the list.

You can also search the message name and select it from the list.

Touch the search bar . Type the message name using the QWERTY keypad that appears and select the required message from the filtered list.



Figure 4-26: Job Select

- 4 Touch the *OK* button to view a preview of the message.
- 5 Touch *OK* at the preview screen to confirm the details. The new message becomes the current message.

Note : You can select a new message while the printer is offline or while it is running. The new message replaces the current message only after you perform step 5.

- 6 Touch the *Home* button to return to the home screen.

To exit the message selection menu at any stage without making any changes, touch the *Cancel* button.

User Editable Fields

If the selected message has a user editable field, the operator will be prompted to review this field and edit if required.

To edit the user field, proceed as follows:

- 1 When a message is selected, the list of user editable fields in the message are displayed (see Figure 4-27).



Figure 4-27: User Editable Fields

- 2 To retain the user field as it is, select the user field, touch *OK* and the field displays a green tick mark (see Figure 4-28).



Figure 4-28: Edited Message

- 3 To change the user field, select the user field and touch *Edit*. The appropriate user field editor, based on the user field type, is displayed for the update. Update the user field as required and touch *OK*.
- 4 Once the user fields have been updated or confirmed, the message preview will be displayed.
- 5 Select *OK* to move the message to print.

Touch To Edit feature

To update and change user fields quickly and easily in a printing message, the user can use the 'Touch To Edit' feature.

- 1 Select the 'Current Message Details Bar' to display the message preview.

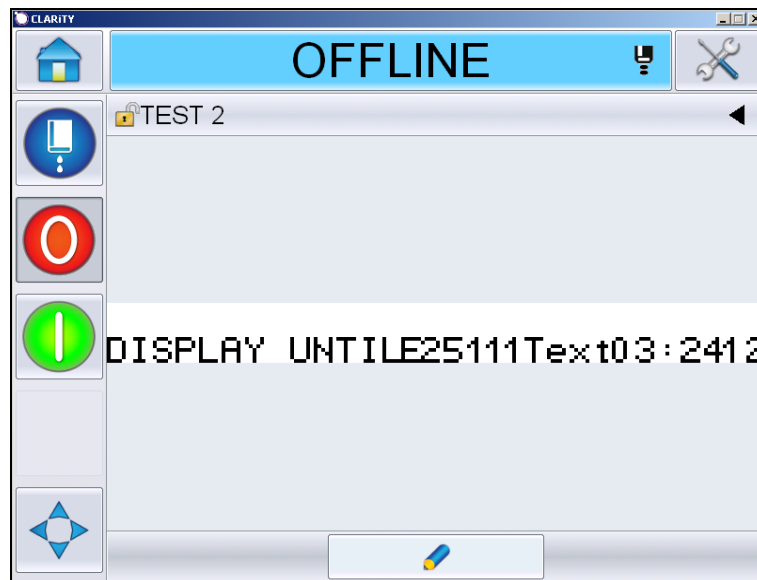

Figure 4-29: Message preview- Touch to edit

- 2 Touch the  button.

- 3 The message opens, with the user editable fields highlighted.



Figure 4-30: User Editable Fields Highlighted

- 4 To edit a user field, touch the user field.
- 5 The appropriate user field editor, based on the user field type, is displayed for the update. Update the user field as required and touch *OK*.

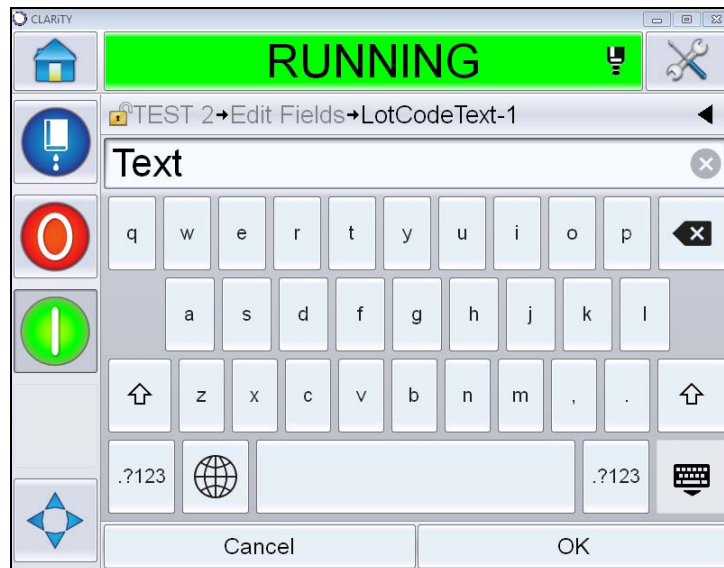

Figure 4-31: User Field Editor

- 6 If there is a second user field, repeat the steps 4 and 5.

- 7 Touch *OK* after editing all the required user fields. The job will be updated in the printer and displayed in the '*current message details bar*' following the next print.

How to Start the Printing

You can use the Quick Start sequence to start the jet. Refer to the service manual for more information. Select the *Jet* button and select either *Quick Start* or *Clean Start*.

Note: *If no faults or warnings are present, the jet can be started or stopped by selecting the status bar.*

- 1 Refer "How to Clean/Quick Start" on page 4-6 to start the 'jet start' sequence.

During the sequence, the printer status bar blinks. The sequence takes approximately one minute to complete. When the sequence is completed, the



icon is displayed continuously. If there are no warnings, the status bar will display '*Running*' status.

- 2 To start the printing process, the following operations are required:
 - Touch the ON button. The background of the button turns grey.
 - The product sensor must send a trigger signal.
 - It may be necessary to adjust message parameters.
 - The photocell level may need to be changed (navigate to *Tools > Setup > Printhead > Print Trigger > Photocell 1 Level*).

Note : *When the print is enabled, the green LED on the beacon, if installed, is turned on continuously. If there are no warnings present, the status bar will turn green and will display 'Running' status.*

Monitor the Printing

When the printer is in operation, use the following to monitor the status:

- The status bar on the display
- The stack light (If Installed)

How to Stop the Printer

Touch the 'Stop' button to stop printing. Printing is disabled and printer status bar shows 'OFFLINE'. The jet is still running.

How to Stop the jet



- Touch the  button to stop the jet.
- You can use the Quick Stop sequences to stop the jet along with stopping the printing. Refer to the service manual for more information. Select the Jet button and select either Quick Stop or Clean Stop.
- During this sequence, the printer status bar blinks in blue color and displays Offline mode. The sequence requires one minute to complete. The status bar will turn white and display 'SHUTDOWN' if no warnings are present.

Note : Do not turn off the printer until the flushing cycle is complete.

Turn off the Printer



Caution

EQUIPMENT DAMAGE. Turn off the printer after the jet shutdown cycle is complete. The failure to follow this caution can cause additional maintenance.



Caution

EQUIPMENT DAMAGE. Do not start and stop the printer many times. When you stop the printer, the printer uses the make-up fluid to flush the system. If you start and stop the printer many times, the printer uses large amount of make-up fluid. The increased use of make up fluid can cause a Ink Core Level High error and low ink viscosity. To prevent this problem, quick start and stop must be used.

Press the main power switch to turn off the printer.

Note: It is recommended to start the printer once in every three months. If the printer is shutdown for more than three months, it is recommended to follow the extended shutdown routine. Refer to “Preparation for Long-term Shutdown (Storage) or Transportation” on page 6-2 for the procedure.

Introduction

This chapter describes how you can use the user interface (UI) to do the following tasks:

- Working with different pages in the User Interface
- Manage messages
- Import and Export Messages
- Availability

Figure 5-1 shows the home page of the Videojet 1560 operator system. For more information on bars and buttons on the home page, refer “Getting started with the User Interface” on page 4-2.

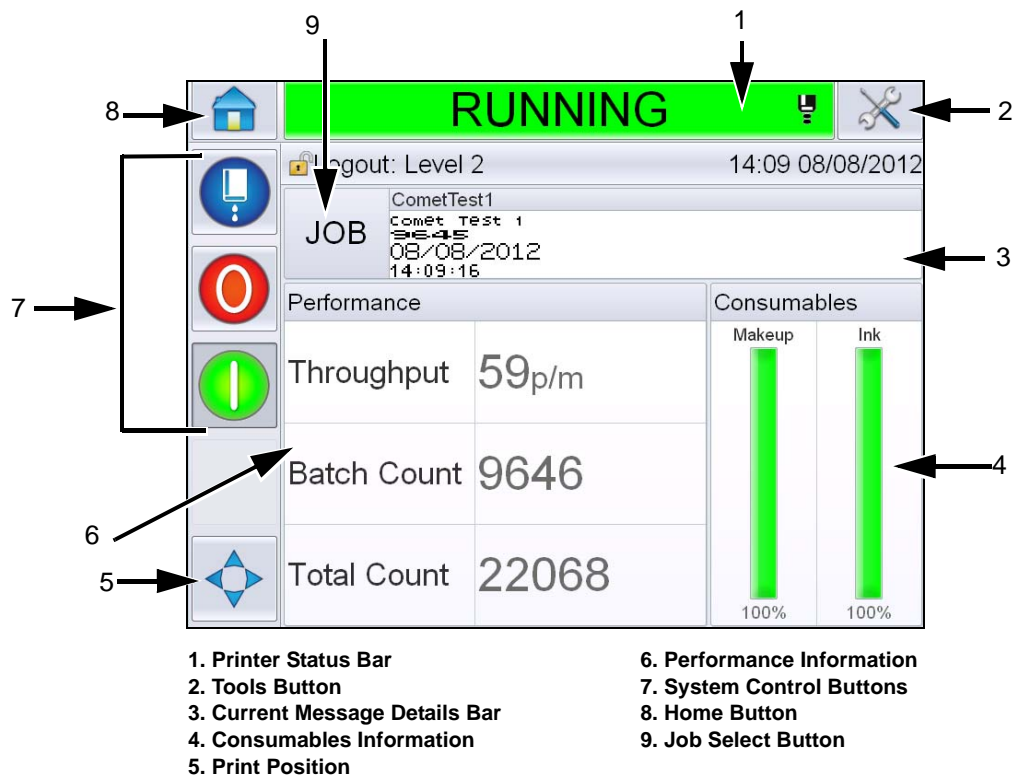

Figure 5-1: Home page

Screen Description

Buttons

The screen has buttons that help you navigate to the key pages of the interface. You can reach any key page from the current page with these buttons (refer to Figure 5-2 and Table 5-1). Use finger to scroll and select. Quick touch, to select an item and firm, held touch to scroll through the menus. Use the keypad and keys to enter the required text, numbers or special characters. To toggle values slide the button from left to right.

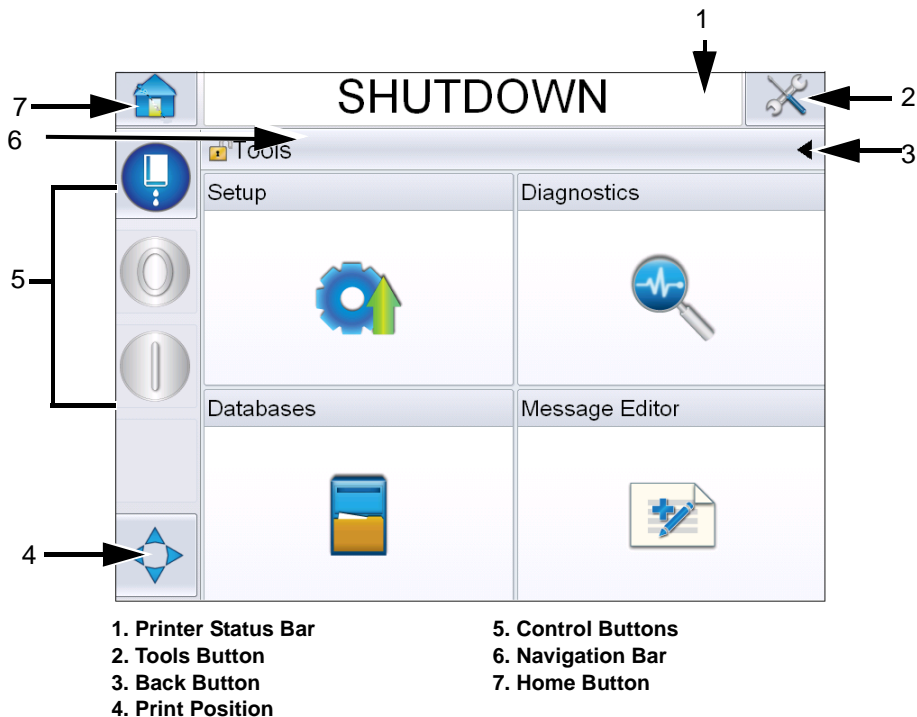

Figure 5-2: Shortcut Icons

Button	Description
Printer Status Bar	Shows the current status of the printer. If any Faults or warnings are present, it takes you to the Fault and Warning Screens.
Tools Button	Takes you to the Setup and Diagnostics Tools page.
Back Button	Takes you to the previous page.

Table 5-1: Shortcut Buttons

Button	Description
Print Position	Helps you change the parameters like <i>Width</i> , <i>Product Delay</i> options and switch <i>On</i> or <i>Off</i> the <i>Reverse</i> and <i>Invert</i> Options.
Control Buttons	Refer to “Getting started with the User Interface” on page 4-2.
Navigation Bar	Indicates the location of your current screen in the menu tree. On the current screen, touch any level displayed on the Navigation Bar to take you to that level.
Home Button	Takes you to the Home page.

Table 5-1: Shortcut Buttons (Continued)

Using the Tools Page

Touch the *Tools* button on the home page to access the tools page. For information on tools page, refer “Using the Tools Page” on page 4-5.

Working with Setup Page

Navigate to *Tools > Setup* (Figure 5-3).

Note: User will be prompted to enter the password to access this page. Refer “How to Login” on page 4-8.



Figure 5-3: Setup Page

The Setup page allows you to access the following parameters:

Icon	Description
Printhead	Allows the setup of the printhead, encoder etc. and gives access to the service menu
Consumables	Allows the reset of batch counter and run hours
Control	Allows the set up of the user interface, message parameters and communications. Also allows to enter manufacturer's password.
Options	Not available

Table 5-2: Setup Page Icons

Printhead Setting

Navigate to *Tools > Setup > Printhead* (Figure 5-4).

Note: For information on printhead setup, refer “Printer Configuration” on page 4-17.

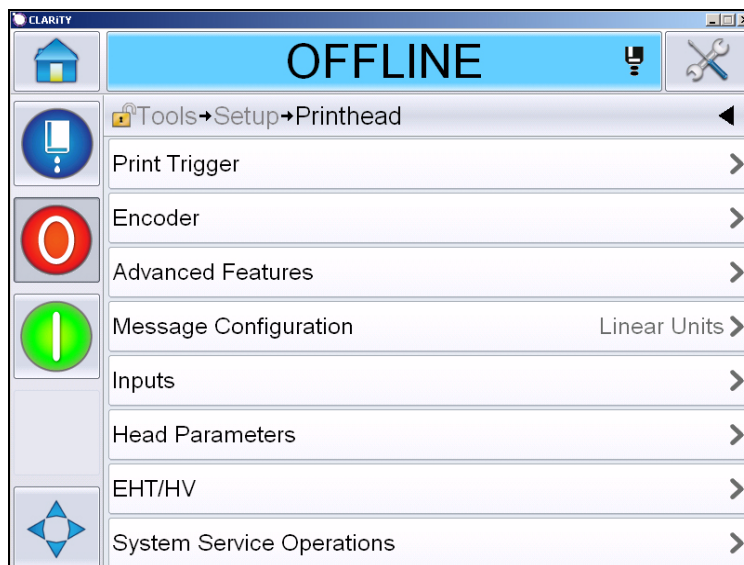

Figure 5-4: Printhead Setting

Consumables

Navigate to *Tools > Setup > Consumables* (Figure 5-5).

Consumables page enables the user to reset the pump run hours, machine run hours and batch counter.

Note: For information on consumables, refer “How to Reset the Counters” on page 4-11 and “How to Reset Run Hours” on page 4-13.



Figure 5-5: Consumables

Working with the Control Setup Page

Navigate to *Tools > Setup > Control* (Figure 5-6).



Figure 5-6: Control Page

The Control page allows the user to set the following parameters:

Parameter	Description
CLARITY® Parameter archives	Allows the user to save current printer configurations and to restore previously saved printer configurations. Refer to the Service Manual for more information.
Internationalisation	<p>Allows the user to set the language of the touch screen, the international region/country which control the date/time formats displayed within the user interface and the measurement unit as per the requirement.</p> 
Recalibrate Touchscreen	<p>Allows the user to recalibrate the touchscreen, if touching the screen does not accurately locate the correct touch screen button. The printer requests the user to touch several crosses which are displayed on the screen, one after the other. The screen is recalibrated when the automated process is complete.</p> <p>Note: <i>If the calibration of the machine has too many errors and does not allow a user to navigate to this screen via the touch panel, the same functionality can be triggered from within CLARITY® Configuration manager.</i></p>
Set Screen Orientation	Allows the user to rotate the entire display through 180 degrees in the event that the touch screen panel is installed in an inverted orientation.

Table 5-3: Control Page Parameters

Parameter	Description
Date and Time	<p>Allows the user to set the system date, time, date codes and shift codes.</p>  <p>Date: Allows the user to update the system date from the calendar.</p> <p>Time: Allows the user to update the system time in 24-hours format.</p>

Table 5-3: Control Page Parameters (Continued)



Parameter	Description
	<p>Date Codes: Allows the user to select and edit the date codes as per the requirements.</p>  <p>Touch the code to view the existing codes.</p> 

Table 5-3: Control Page Parameters (Continued)

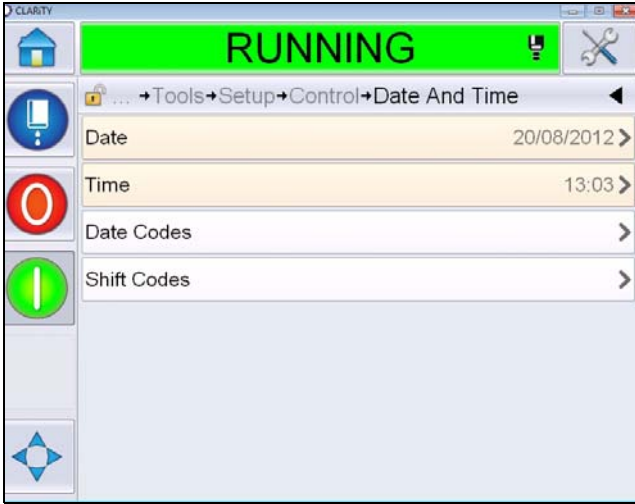

Parameter	Description
	<p>Touch the code to edit if required and touch OK.</p> 
	<p>Shift Codes: Allows the user to add and edit Shift Codes. Select 'Shift Code' to view the existing shift codes. Touch  to add a new shift code.</p> 

Table 5-3: Control Page Parameters (Continued)

Parameter	Description
	<p>Touch the shift code to define the shift details. The user can define the shift name, shift start time and days for which the shift is applicable.</p>  <p>The screenshot shows a control interface with a green 'RUNNING' status bar. Below it, a breadcrumb trail reads 'Date And Time → Shift Codes → Shift 1'. The settings list includes: Shift (Shift1), Start Time (<0:0:0>), and days of the week (Monday through Saturday, all set to 'No').</p>
<p>Default Message Parameters</p>	<p>Allows the user to set the default message parameters.</p>  <p>The screenshot shows a control interface with a blue 'OFFLINE' status bar. Below it, a breadcrumb trail reads 'Control → Default Message Parameters'. The settings list includes: Width (101.60mm), Character Height (6), Character Gap (1), Product Delay (25.40mm), Reverse (Off), Invert (Off), Select Raster Substitute (16-high), and Raster Substitution (On).</p> <p>Width: Allows the user to set the required message width. The minimum, maximum and default values are set in the software and the user can quickly set any one of them as the message width by touching. Use the numbers pad to enter any other value.</p> <p>Character Height: Allows the user to set the required character height.</p>

Table 5-3: Control Page Parameters (Continued)

Parameter	Description
	Character Gap: Allows the user to set the required message character gaps.
	Product Delay: Allows the user to set the product delay (the time between the start of product (trigger point) and the print start position).
	Reverse: Reversed (back to front) character printing.
	Invert: Inverted (upside down) character printing.
	Select Raster Substitute: Lists the file name of the selected raster.
	Raster Substitution: When selected ON the printer automatically selects the appropriate raster for the line running speed.
	Raster Repeat: Sets the count for the same raster/ stroke that needs to be printed. This allows characters to be emboldened.
	Bold Print Adjustment: Sets the value for Bold Print Adjustment.
Communications	Enables resetting of all serial communication ports in the event that their setup has become corrupted along with the internal network configuration.
Contact Information	Enables the user to enter the service information.

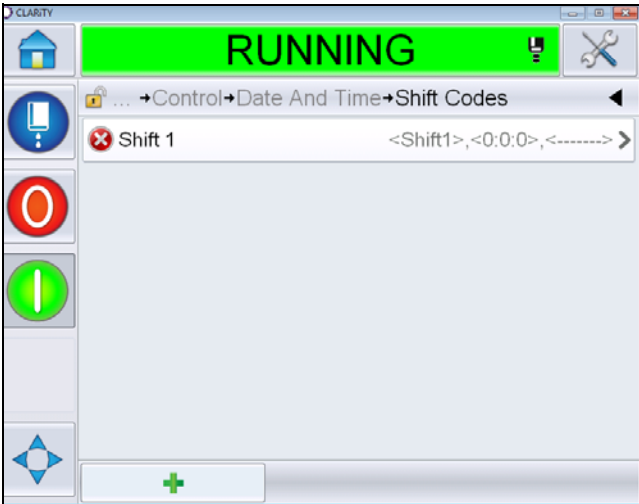
Table 5-3: Control Page Parameters (Continued)

Working with Options Setup Page

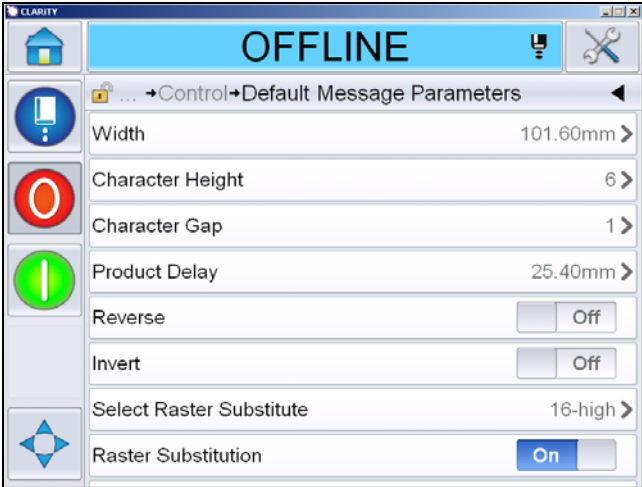
Navigate to *Tools > Setup > Options* (Figure 5-7). Currently by default there are no options.

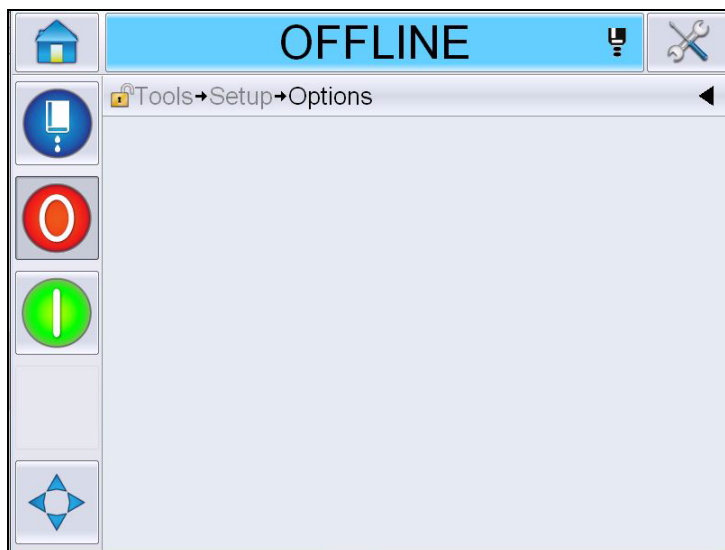

Figure 5-7: Options Page

Working with Diagnostics

Navigate to *Tools > Diagnostics* (Figure 5-8).



Figure 5-8: Diagnostics Page

The diagnostics page allows you to access the following pages:

Icon	Description
Printhead	Allows the user to clear errors and warnings. Shows the Diagnostics Screens, Event Log, Inputs, Outputs, Photocell Status, States Screen, Valves and Input Data Mismatch.
Consumables	Shows the Ink, Makeup, Ink core, Printer Life and Contact Information.
Control	Shows the Software Versions, System Information and Communication port. Allows to edit the Image Update Queue.
Options	Not Available

Table 5-4: Diagnostics Page Icons

Working with Printhead Diagnostics

Navigate to *Tools > Diagnostics > Printhead* (Figure 5-9).

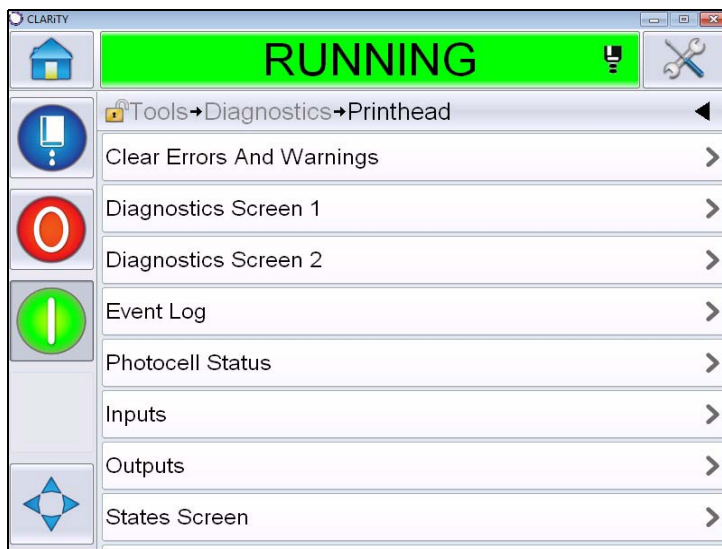

Figure 5-9: Printhead Diagnostics Page

The Printhead diagnostics page allows the user to access the following parameters:

Parameter	Description
Clear Errors And Warnings	Allows the user to clear all the error messages and warnings. The UI asks for a confirmation before clearing all the errors and warnings.
Diagnostics Screen 1 and 2	Shows the current value of different parameters to help the user to find the faults.
Event Log	Shows the log of events responsible for printer downtime. For more information, refer “Overall Equipment Effectiveness - Availability Tools” on page 5-73.
Photocell Status	Allows the user to view the status of photocell levels 1 and 2.
Inputs	Allows the user to view the status of inputs.
Outputs	Shows the status of a physical output on the printer.
States Screen	Shows the current status of the printer.
Input Data Mismatch	This appears following an update from one software version to the next if there is any mismatch in data.
Valves	Shows the status of the valves.

Table 5-5: Printhead Diagnostics Parameters

Diagnostics Screens 1 and 2

This screen shows the current value of different parameters to help you find the faults. Navigate to *Tools > Diagnostics > Printhead > Diagnostics Screen 1* (Figure 5-10).

RUNNING	
→Printhead→Diagnostics Screen 1	
Target Pressure	2.60bar
Temperature Compensated Target Pressure	2.60bar
Actual Pressure	2.60bar
Head Temperature	35.0°
Nozzle Temperature	34.4°
Velocity Setpoint	20.000
Actual Velocity	20.048
Drop Frequency	76.804kHz

Figure 5-10: Diagnostics Screen 1

RUNNING	
→Printhead→Diagnostics Screen 1	
Actual Velocity	20.060
Drop Frequency	76.804kHz
Modulation Voltage Setpoint	113
Modulation Current	251
Printing Phase	9
Phasing Threshold	200
Velocity Threshold	200
Phase Profile	1000000001111111

Figure 5-11: Diagnostics Screen 1 (continued)

Parameter	Description
Target Pressure	Empirically and theoretically determined pressure required to match the actual velocity to the set point.
Temperature Compensated Target Pressure	The ideal pressure for the current temperature.
Actual Pressure	Pressure measured at the pressure transducer in the Core.
Head Temperature	Temperature measured by the temperature sensor in the printhead.
Nozzle Temperature	Shows the temperature of the nozzle.
Velocity Setpoint	Required drop velocity.
Actual Velocity	Drop speed measured in the printhead.
Drop Frequency	Actual nozzle frequency.
Modulation Voltage Setpoint	Actual modulation voltage.
Modulation Current	Actual modulation current.
Printing Phase	Actual phase selected for printing.
Phasing Threshold	Threshold value required to optimize the actual phase profile (obtain eight 1's and eight 0's).
Velocity Threshold	Threshold value required to optimize the actual velocity profile.
Phase Profile	Digital representation of the results of the actual phasing test.

Table 5-6: Diagnostics Screen 1

Note: All the values are in metric.

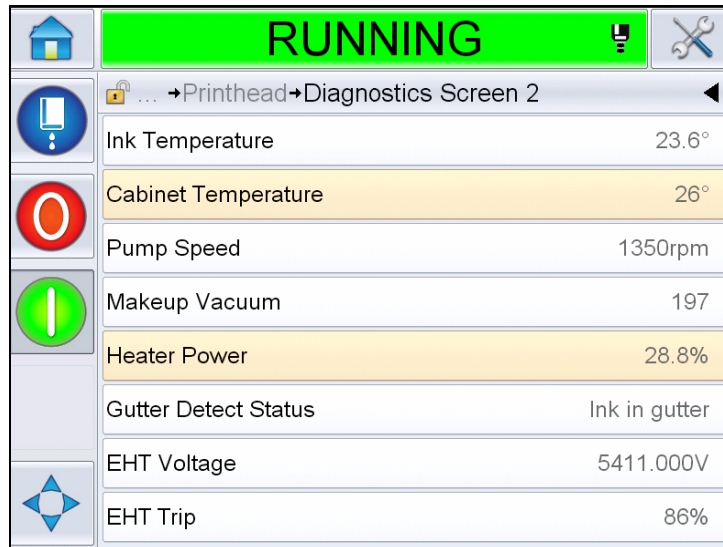

Figure 5-12: Diagnostics Screen 2

Parameter	Description
Ink Temperature	Temperature measured by the temperature sensor in the Core.
Cabinet Temperature	Temperature measured by the sensor on the CSB.
Pump Speed	Speed of the pump measured in rpm.
Makeup Vacuum	Use this option to view the measured makeup vacuum pressure.
Heater Power	Percentage of current heater power with respect to the maximum allowable.
Gutter Detect Status	Actual state of gutter detect circuitry in the printhead and on the CSB.
EHT Voltage	Actual EHT voltage.
EHT Trip	Measured EHT leakage current with respect to the maximum allowable value.

Table 5-7: Diagnostics Screen 2

Event Log

Shows the log of events responsible for printer downtime. For more information, refer “Overall Equipment Effectiveness - Availability Tools” on page 5-73.

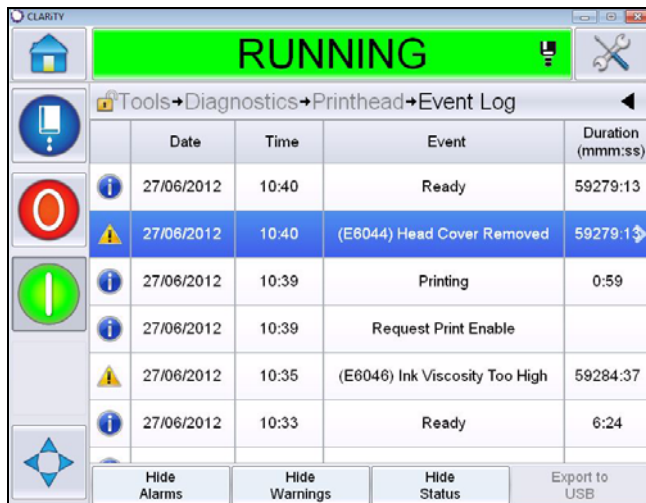

Figure 5-13: Event log

Photocell Status

This menu allows the user to view the status of photocell levels 1 and 2.

Inputs

Navigate to *Tools > Diagnostics > Printhead > Inputs* (Figure 5-14 on page 5-19) to view the status of the following inputs:

Parameter	Description
Printer Present	Shows whether the printer is ready for printing.
Counter Advance	Shows the On/Off status of counter advance.
Counter Reset	Shows the On/Off status of counter reset.
Ink Jet Stop	Shows the On/Off status of ink jet stop.
Spare Input 1	Shows the On/Off status of spare input 1
Spare Input 2	Shows the On/Off status of spare input 2.
24 Volts Supply	Shows the status of the 24 V supply.
POE Supply	Show the status of the Power Over Ethernet (POE) supply (not available for Videojet 1560).
UI PCB Temperature	Shows the temperature of the UI PCB.

Table 5-8: Inputs Screen

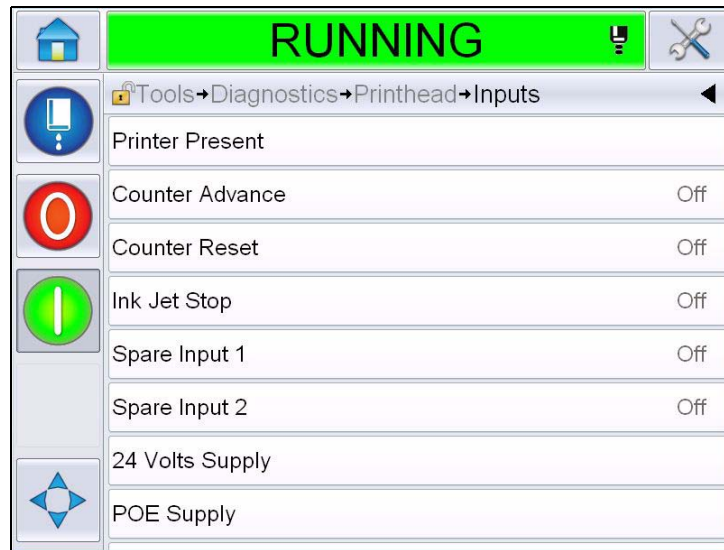

Figure 5-14: Printhead Inputs Diagnostics Page

Outputs

Navigate to *Tools > Diagnostics > Printhead > Outputs* (Figure 5-15).



Figure 5-15: Printhead Outputs Diagnostics Page

Each button shows the status of a physical output on the printer. Touching the toggle button allows the user to force the state of an output, On or Off, which is useful for diagnostic purposes.

States Screen

Navigate to *Tools > Diagnostics > Printhead > States Screen* (Figure 5-16).



Figure 5-16: Printhead States Screen

Input Data Mismatch

Navigate to *Tools > Diagnostics > Printhead > Input Data Mismatch* (Figure 5-17). This will generally appear following an update from one software version to the next if there is any mismatch in data.

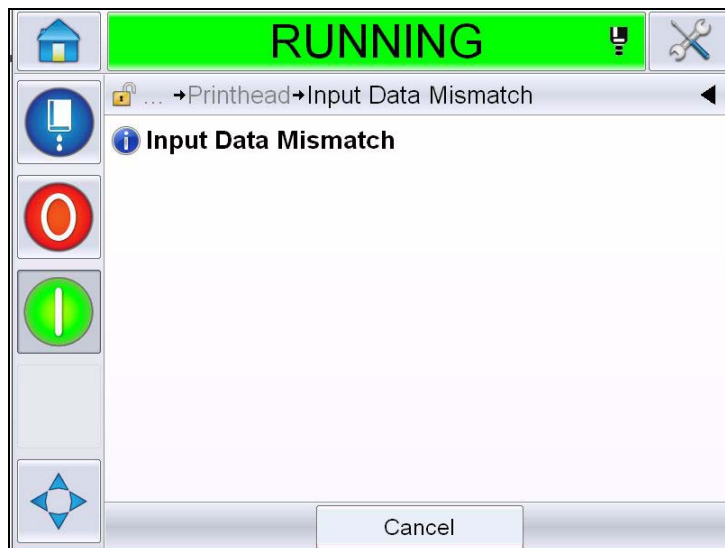

Figure 5-17: Input Data Mismatch

Valves

Shows the status of the valves.

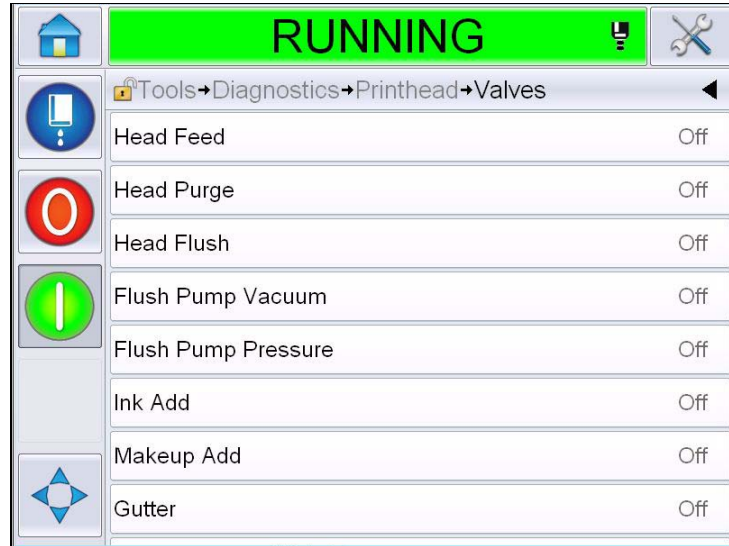

Figure 5-18: Valves

Working with Consumables Diagnostics

Navigate to *Tools > Diagnostics > Consumables*. This screen enables the user to view the following informations:

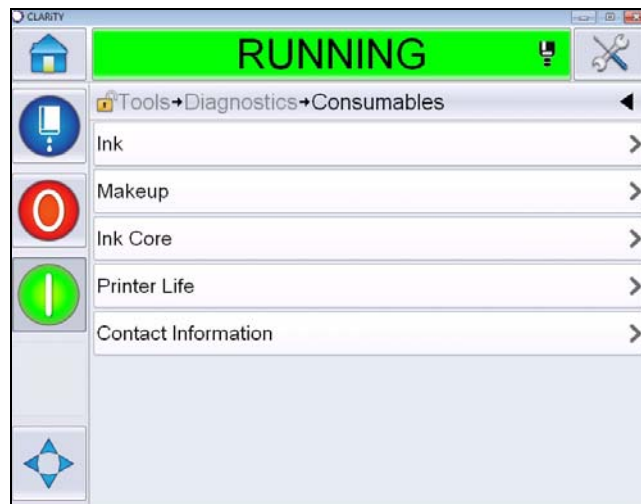

Figure 5-19: Consumables Diagnostics

Parameter	Description
Ink	 <p>The screenshot shows the CLEARITY diagnostics interface. At the top, a green bar displays 'RUNNING'. Below it, a breadcrumb trail reads 'Tools → Diagnostics → Consumables → Ink'. A list of parameters is shown with their corresponding values:</p> <ul style="list-style-type: none"> Ink Level: 0 Consumable Part Number: V501A-D Serial Number: 393634463734 Production Batch Code: 0/0/0/AB Expiry Date: 11/8/2011 Makeup Part Number: V701A-D Ink Cartridge Refit Count: 55 Viscosity Coefficient 1: 8 <p>Below the screenshot, the following descriptions are provided for each parameter:</p> <ul style="list-style-type: none"> Ink Level: Displays the Ink Level in percentage. Consumable Part Number: Displays the ink part number. Serial Number: Displays the ink serial number. Production Batch Code: Displays the code of the production batch. Expiry Date: Displays the expiry date of the ink cartridge. Makeup Part Number: Displays the makeup part number. Ink Cartridge Refit Count: Displays the number of times the ink cartridge has been replaced. Viscosity Coefficient 1,2,3: Displays reference data for the ink viscosity

Table 5-9: Diagnostics Screen 2

Parameter	Description
Makeup	 <p>The screenshot shows a diagnostic screen with a green 'RUNNING' header. Below it is a breadcrumb trail: Tools → Diagnostics → Consumables → Makeup. The main area contains a list of parameters with their values: Makeup Level (47), Consumable Part Number (V701-D), Serial Number (000003813AD5), Production Batch Code (12/86/0/EG), Expiry Date (26/3/2014), and Cartridge Refit Count (2). Navigation icons are visible on the left and right sides of the screen.</p> <p>Makeup Level: Displays the makeup level in percentage.</p> <p>Consumable Part Number: Displays the makeup part number</p> <p>Serial Number: Displays the makeup serial number</p> <p>Production Batch Code: Displays the code of the production batch.</p> <p>Expiry Date: Displays the expiry date of the makeup cartridge</p> <p>Cartridge Refit Count: Displays the number of times the makeup cartridge has been replaced</p>

Table 5-9: Diagnostics Screen 2 (Continued)

Parameter	Description
Ink Core	<p>Ink Core Level: Displays the ink core level in percentage.</p> <p>Serial Number: Displays the ink core serial number.</p> <p>Run Hours: Displays the ink core run hours.</p> <p>Ink Reference: Displays the ink part number</p> <p>Makeup Reference: Displays the makeup part number.</p> <p>Viscosity Coefficient 1,2,3: Displays reference data for the ink viscosity.</p> <p>Days used: Displays the number of days the ink core has been in service.</p> <p>Days remaining: Displays the number of days of ink core life remaining.</p> <p>Remaining Hours: Displays the remaining operation hours available, when the ink core has reached its rated life.</p>
Printer Life	<p>Pump Run Hours: Displays the pump run hours.</p> <p>Machine Run Hours: Displays the Machine Run Hours.</p> <p>System Million Drops Counter: Displays the number of millions of drops printed.</p>
Contact Information	Displays the contact information.

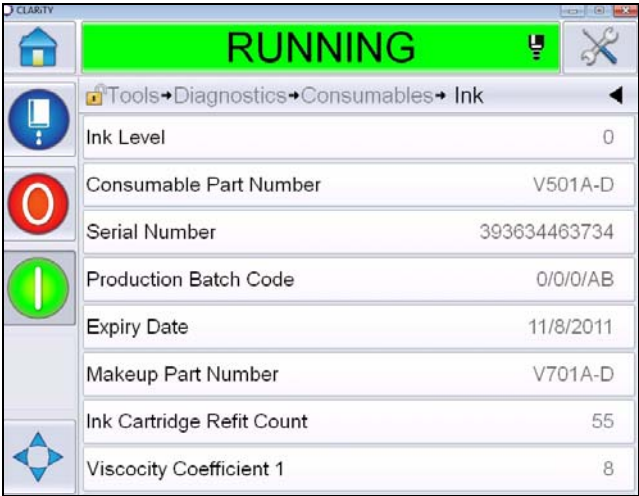
Table 5-9: Diagnostics Screen 2 (Continued)

Working with Control Diagnostics

Navigate to *Tools > Diagnostics > Control*. (Figure 5-20).

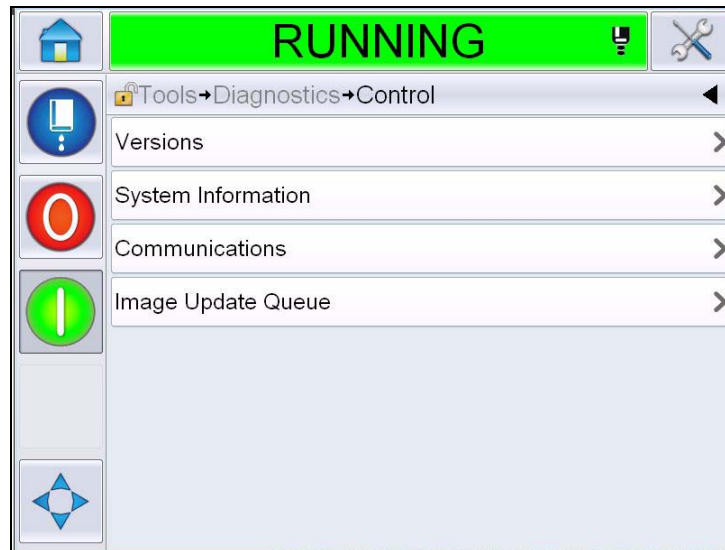

Figure 5-20: Control Parameters

The following parameters can be accessed in this page:

Parameter	Description
<p>Versions</p>	<p>Displays the software versions of the various software components installed in the printer. The most important number displayed is the Software Part Number. This is the master version number and all the other data displayed is of secondary importance.</p> <p><i>Note: If there is any inconsistency among the software components that are installed in the printer, the Software Part Number displays the message 'Incompatible Software Versions'. If this is seen, a CLARiTY® software update must be performed, otherwise the coder may perform in an unpredictable manner.</i></p> 
<p>System Information</p>	<p>Displays the system informations such as the PCB Serial Number, CPU speed, Print Engine Type and so on.</p> 

Table 5-10: Printhead Inputs Parameters

Parameter	Description
<p>Communication</p>	<p>Displays the following parameters: TCP/IP: Displays the status of the ethernet port. IP Address: Displays the IP Address of the controller Subnet Mask: Displays the Subnet Mask number CLARiTY Communications: Text Communications: Indicates if the Text Communications has been enabled for this coder Note: It is recommended to connect the printer to a network via a switch always</p> 
<p>Image Update Queue</p>	<p>Allows the queue of the print messages to be updated, where a number of print messages have been sent to the printer.</p>

Table 5-10: Printhead Inputs Parameters (Continued)

Working With Databases

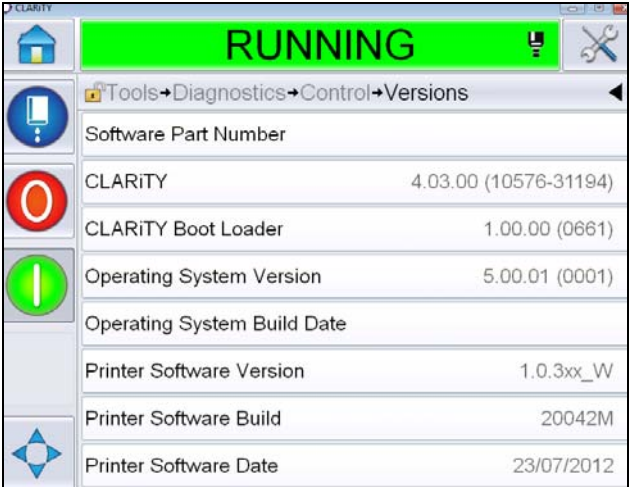
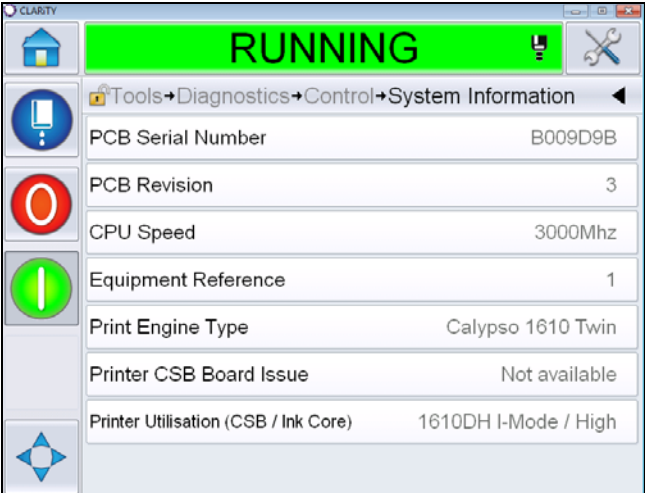
Navigate to *Tools > Databases* (Figure 5-21)

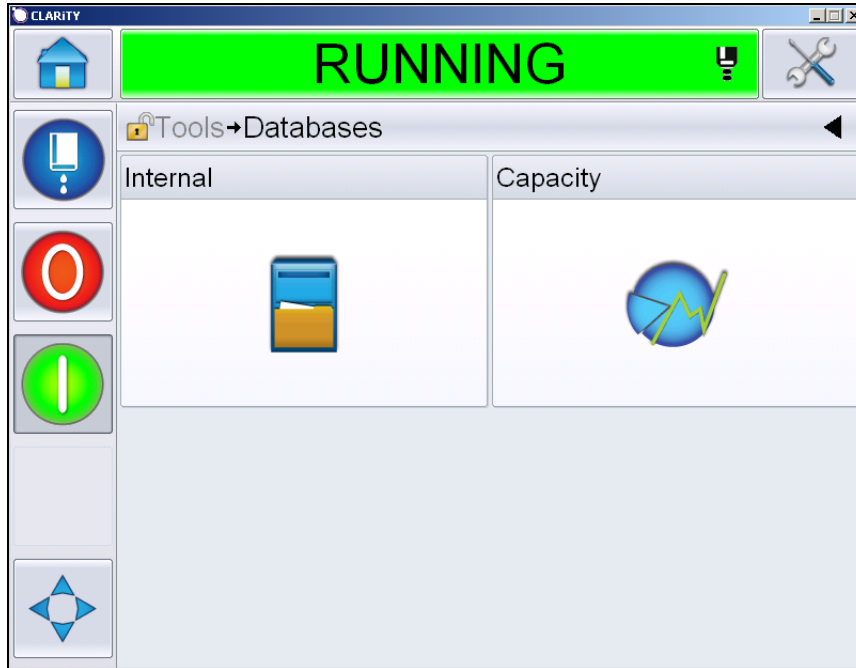

Figure 5-21: Databases

The databases page allows you to access the following pages:

Icon	Description
Internal	Shows the job stored in the printer. Allows the user to delete the jobs.
Capacity	Shows the details like the space used in the internal database and space available.
External	Shows the messages stored in the memory stick. This option is available only when the USB memory stick containing the folder JOBS is inserted to the USB port

Table 5-11: Databases Page Icons

Working with Message Editor

Navigate to *Tools > Message Editor* (Figure 5-22)



Figure 5-22: Message Editor

The message editor page allows you to access the following pages:

- Create Message: Allows the user to create a message.
- Edit Message: Allows the user to modify the message.

Manage Messages

To Create a Message

Do the following tasks to create a message:

- 1 Navigate to *Tools > Message Editor* from the *Home Page*.

- 2 Touch  to create a new message. This displays a blank message page.

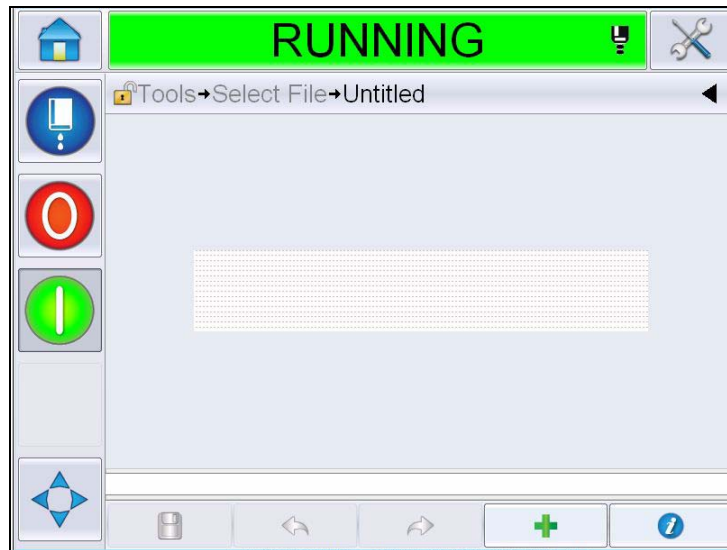



Figure 5-23: Blank Message Page

Note: Messages will be created with default message parameters. To change the default message parameters go to *Tools > Setup > Control > Default Message Parameters*. For more information refer “Default Message Parameters” on page 5-11 in Table 5-3

To change the current message parameters of the current message only,

Touch  on the message page. For more information refer “To change Current Message Parameters” on page 5-68.

Note: Double clicking outside the message field will zoom in or zoom out the message field.

- 3 Touch . Displays the *Add Field* Page (Figure 5-24 on page 5-31).

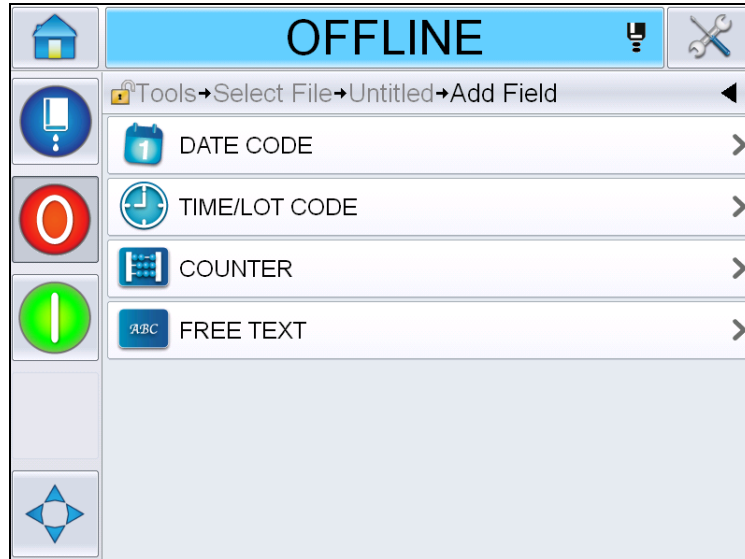

Figure 5-24: Add Field Page

To Add Date Code Field

- 4 Select *Date Code* field. The following page is displayed (Figure 5-25).



Figure 5-25: Date Type Page

- 5 Select the date type. Displays *Select Date Prefix* page (Figure 5-26 on page 5-32).



Figure 5-26: Date Prefix Page

- 6 Select the required date prefix. For example, selecting D.O.M. Displays the *Date Format* page for D.O.M (Figure 5-27). For information on date formats refer Table 5-13 on page 5-41.

Note: The user can select 'None' if no Date Prefix is required.

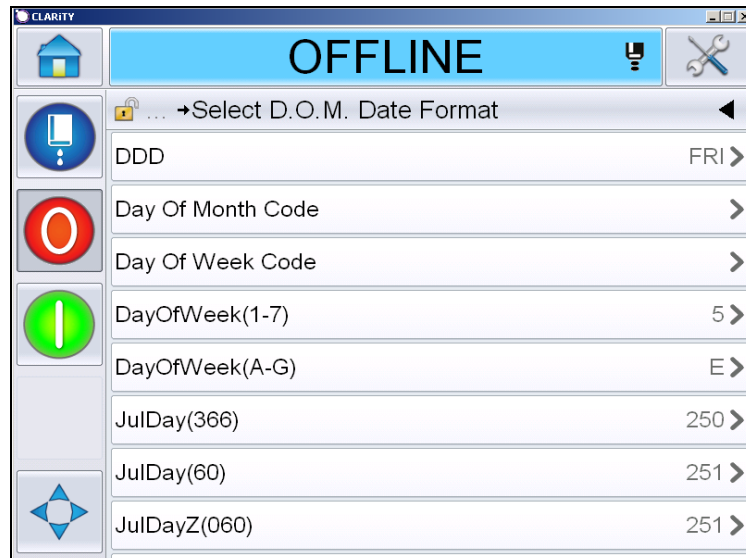

Figure 5-27: Date Format Page

7 Displays the *Date Field Properties* page (Figure 5-28 on page 5-33).

Note: You can touch and drag the fields to change the order.



Note: The user can add a field by touching the  button or remove a field by touching the  button and preview the results in the preview bar.



Figure 5-28: Date Field Properties Page

Parameters	Description
Date Prefix	Shows the type of Date Prefix selected. For example, D.O.M, Made On, Born On etc.
Date format	Shows the type of Date Format selected. For example, Day Of Month Code, Day Of Week Code etc.
Separator	Shows the type of Separator selected. For example, Colon (:), Comma (,), Dash (-) etc.
Time period	Allows the user to select the type of time period between Day, Month and Year.
Default date offset	Allows the user to set the default date offset.

Table 5-12: Date Field Properties

Parameters	Description
User editable	By default it is set to <i>No</i> . If you select <i>Yes</i> , the following options would be enabled.
	Minimum Date Offset: Allows the user to enter the minimum value of Date Offset.
	Maximum Date Offset: Allows the user to enter the maximum value of Date Offset
	Prompt Message: Allows the user to enter the text which will be prompted while selecting the message to enter the information.
Date locale	Allows the user to set any text in the date field into the selected language from the list of languages/locales. Note: For different calendars (Non-Gregorian), the selection of the language/locale will also change the date to the locale date (for example, Arabic- Saudi Arabia) and display it as expected in that region.
Encryption	Allows the user to choose the type of encryption for the message.

Table 5-12: Date Field Properties

- 8 Select and change the properties as per the requirement and touch *OK*.

The message with selected format is displayed on the *Message* page (Figure 5-29). Proceed to Step 18 on Page 5-39 to save the message or go to the next step to add another field.

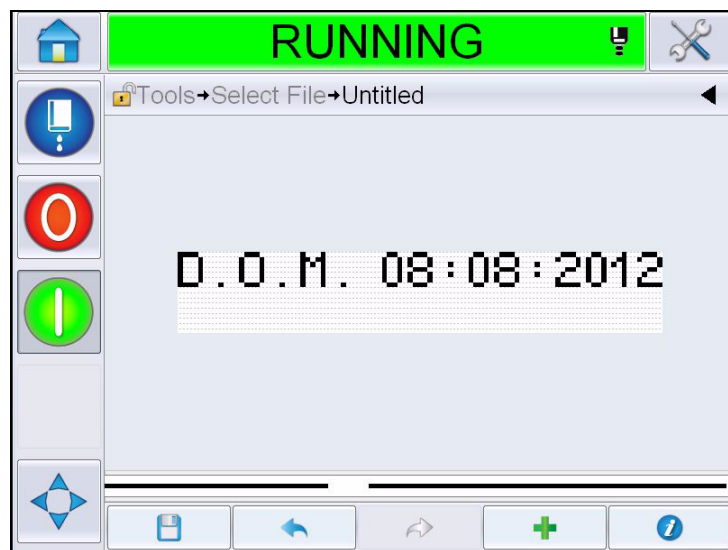

Figure 5-29: Message Page

To Add Time/Lot Code Field



- 9 Touch . Displays the *Add Field* Page. Select Time/Lot Code field. Displays the *Lot Code Field Properties* page (Figure 5-30).

Figure 5-30: Lot Code Field Properties Page

- 10 Select the required field that builds up the required lot code from the following:
- Factory Reference
 - Line Reference
 - Separator
 - Time Format
 - Year Format
 - Text

For more information on lot code fields refer Table 5-15 on page 5-44.

Note: You can touch and drag the fields to change the order.



Note: The user can add a field by touching the  button or remove a field by touching the  button and preview the result in the preview bar. See Figure 5-31 on page 5-36 with selected fields and preview bar.



Figure 5-31: Preview Bar

- 11 Once the lot code fields are selected and arranged as required, select each field and enter the required data.
Touch *OK* to add to the message
- 12 The message with selected format is displayed on the *Message* page (Figure 5-32). Proceed to Step 18 on Page 5-39 to save the message or go to the next step to add another field.

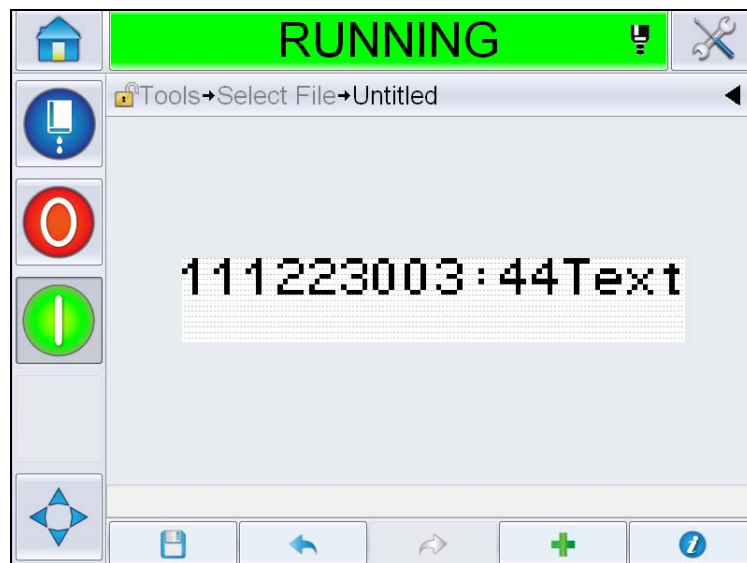



Figure 5-32: Time/Lot Code Field on Message Page

To Add Counter Field

- 13 Touch . Displays the *Add Field* Page. Select Counter field. Displays the *Counter Field Properties* page (Figure 5-33). For information on counter fields refer Table 5-17 on page 5-49.

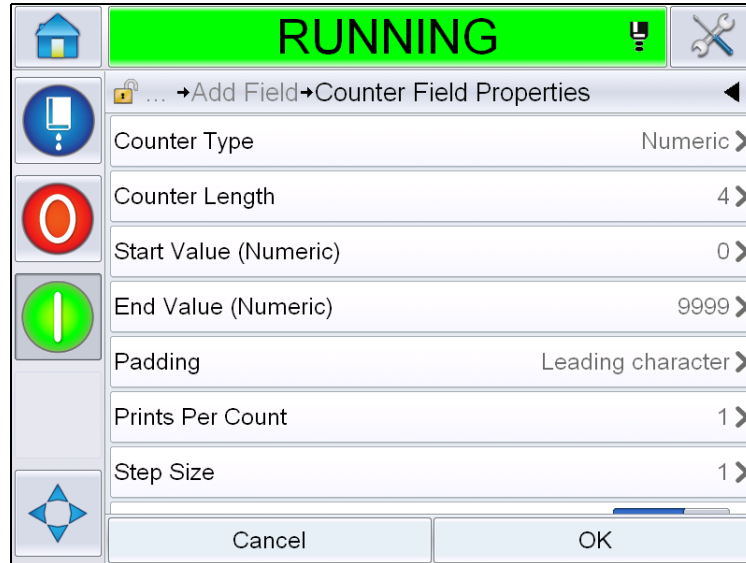

Figure 5-33: Counter Field Properties Page

- 14 Select and set the parameters as per the requirement and touch OK. The message with selected format is displayed on the *Message* page (Figure 5-34). Proceed to Step 18 on Page 5-39 to save the message or go to the next step to add another field.

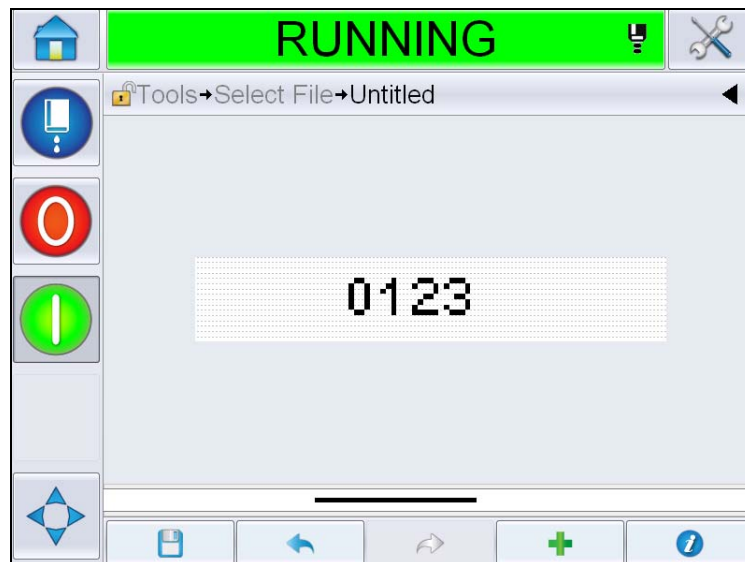

Figure 5-34: Counter Field on Message Page

To Add Free Text

- 15 Touch . Displays the *Add Field* Page. Select Free Text field. Displays the *QWERTY* page to enter the free text. (Figure 5-35).



Figure 5-35: Enter Free Text

- 16 Enter the text and touch *OK*. Displays the *Text Field Properties* Page. For information on text field options refer Table 5-18 on page 5-51.

Note: The options 'Prompt', 'Maximum Length', 'Fixed Length' are visible only when the 'User Editable' option is set to 'Yes'.

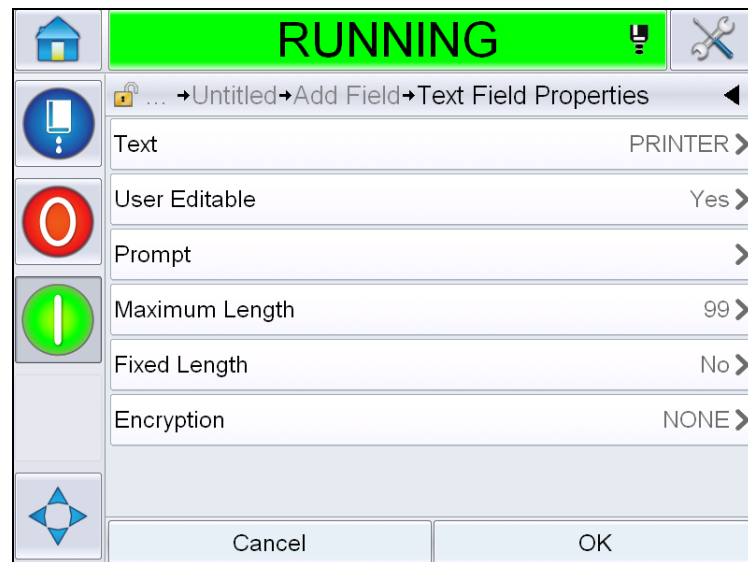

Figure 5-36: Text Field Properties Page

- 17 Select and set the parameters as per the requirement and touch OK. The message with free text is displayed on the *Message* page (Figure 5-37).

Note: When a free text field is added, it is automatically in the same font as the previous field.

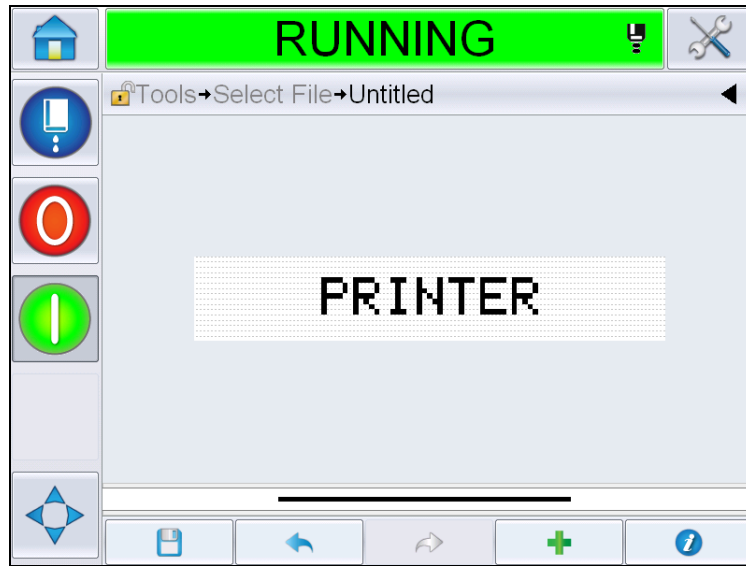

Figure 5-37: Free Text on Message Page

- 18 Touch the save button . Enter the message name in the field.



Figure 5-38: Save Message

- 19 Touch the *OK* button and the new message is created. The message is now stored in the internal database.

Note: Each message name must be unique. If a message with the name you have entered already exists, you will be asked if you wish to overwrite the file. If you select No, you must resave the file and enter a new message name.

*Note: The message name must not include any invalid characters (for example, \, /, :, ?, *, ", <, >). The message will not be saved if any of these characters are used.*

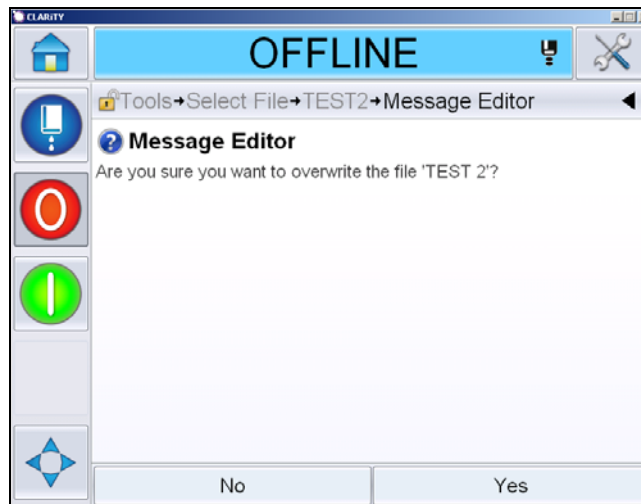

Figure 5-39: Message Editor Overwrite

User Fields

The User Fields contain the information entered by the user. This information can be of any format as follows:

- Date Code
- Time/Lot Code
- Counter
- Free Text

When a user field is inserted into a message, the content of the user field is copied into the message during the print time. When the user field changes, the message is updated automatically and printed.

The pre-defined user fields in the user interface are described in the Tables below:

Date Code

Date Code - Format

Field Name	Description	Mnemonic Code and Example
DDD	Shows the current week day in three letter character in uppercase.	MON
Day of Month Code	Shows the current day of the month	9
Day of Week Code	Shows the current day of the week (alphabet).	A
DayOfWeek(1-7)	Shows the current day of the week (numerical)	1
DayOfWeek(A-G)	Shows the current day of the week (alphabet).	A
JulDay(366)	The day of the year (1-365*). *366 days for Leap Year where Day 366= 29th February	54
JulDay(60)	The day of the year (1-365*). *366 days for Leap Year where day 60 = 29th February	60
JulDayZ(060)	The day of the year (001- 365*). *366 days for Leap Year with leading zeros, where day 060 = 29th February	060
JulDayZ(366)	The day of the year (001- 365*) with leading zeros *366 days for Leap Year where day 366 = 29th February	054
MM	Shows the current month of the year	04

Table 5-13: Date Code/Format

Field Name	Description	Mnemonic Code and Example
MMM	Show the current month of the year as three letter character in uppercase.	APR
MMMM	Shows the current month of the year in alphabetical form in uppercase.	APRIL
MMMyy	Shows the current month as three letter character and year in numerical form, but without separator.	APR12
Mmm	Show the current month of the year as three letter character.	Apr
Mmmyy	Shows the current month as three letter character with year in numerical form.	Apr12
Month Code	Shows the month code.	AL
Single Digit Day of Month	Shows the day of the month in single digit.	9
Week	Shows the week of the year in numerical form.	15
Week of Year Code	Shows the week of the year in numerical form.	2
WeekZ	Shows the week of the year in numerical form and adds leading zeros.	02
Year of Decade Code	Shows the year of the decade in alphabetical form (A-J). Note: The first year of the decade starts with 0 (2010).	C
dd	Shows the current date in two digit format.	09

Table 5-13: Date Code/Format (Continued)

Field Name	Description	Mnemonic Code and Example
ddMMM	Shows the current date as day and month in alphabetical form in uppercase.	09APR
ddMMMyyyy	Shows the current date as day, month in alphabetical form in uppercase and year in numerical form.	09APR2012
ddMMyy	Shows the current date as day, month and year in two digits.	090412
ddMMyyyy	Shows the current date as day, month and year in numerical form. Note: Shows year in four digits.	09042012
ddMmm	Shows the current date as day and month. Note: Month is shown as three letter character.	09Apr
ddMmmyyyy	Shows the current day as day, month and year. Note: Month is shown as three letter character with first letter in capital. Year is shown as four digit character.	09Apr2012
y(2010=0)	Shows the year in single digit numerical form. Note: 2010 is set as zero.	2
y(2010=10)	Shows the year in numerical form. Note: 2010 is set as 10.	12
yy	Shows the current year in two digit numerical form.	12
yyyy	Shows the current year in four digit numerical form.	2012

Table 5-13: Date Code/Format (Continued)

Date Code - Separator

Field Name	Description	Example
Back Slash	Separates the code with a back slash.	09\04\2012
Colon	Separates the code with a colon.	09:04:2012
Comma	Separates the code with a comma.	09,04,2012
Dash	Separates the code with a dash line.	09-04-2012
Forward Slash	Separates the code with a forward slash.	09/04/2012
Full Stop	Separates the code with a full stop.	09.04.2012
None	This format will not have any separator.	09042012
Space	Separates the code with a space.	09 04 2012

Table 5-14: Date Code/Separator

Time/Lot Code

Field	Description	Example
Factory Reference	Allows the user to enter a factory reference	
Line Reference	Allows the user to enter a production line reference	
Year Format	Allows the user to select the required year format from the following list: <ul style="list-style-type: none"> • y(2010=0) • y(2010=10) • yy • yyyy 	If the current year is 2012, year appears as listed below for different options. <ul style="list-style-type: none"> • y(2010=0) - 2 • y(2010=10) - 12 • yy - 12 • yyyy - 2012

Table 5-15: Time/Lot Code

Field	Description	Example
Julian Day Format	Allows the user to select the format as listed below: <ul style="list-style-type: none"> • JulDay(366) • JulDay(60) • JulDayZ(366) • JulDayZ(060) 	
Time Format	Allows the user to select the required format. Refer to Table 5-16 on page 5-46 for more information.	
Separator	Separates the lot code field with separator like Backslash (\), Colon (:), Comma (,), Dash (-), Full Stop (.), None and Space.	09\04\2012
Text	Allows the user to write the required text.	
Text User Editable	Allows the user to make the text field editable or non editable. The fields, Prompt, Maximum Length and Fixed Length are visible only when this option is set to Yes.	
Prompt	Allows the user to enter the text that will prompt the message selector on the information to enter text.	Enter Batch Number
Maximum Length	Maximum Length of the user editable field.	
Fixed Length	Restricts the user entered field to a fixed length.	

Table 5-15: Time/Lot Code

Field Name	Description	Example
H	Shows the current hour in single digit. Note: Displays the hour in 24 hour format.	9
HH	Shows the current hour in two digit. Note: Displays the hour in 24 hour format.	17
HHmm	Shows the current hour and minute in two digits without a separator. Note: Displays the hour in 24 hour format.	0509
HHmmss	Shows the current hour, minute and second in two digits without a separator. Note: Displays the hour in 24 hour format.	050929
Hour Code	Shows the hour code in alphabetical form	V
Minute Code	Shows the minute code in two letter alphabetical form	EG
MinuteOfDay	Shows the Minute of the day	635
MinuteOfDayZ	Shows the minute of the day and adds leading zeros	0635
Shift Code	Shows the shift code	SC
a or p	Displays 'a' if the current hour is in ante meridian or 'p' if the current hour is in post meridian.	a

Table 5-16: Time Format

Field Name	Description	Example
am or pm	Displays am, if the current hour is in ante meridian or pm if the current hour is in post meridian	5 am
h	Displays the hour in single digit. Note: Displays the hour in 12 hour format.	5
hh	Shows the current hour in two digit. Note: Displays the hour in 12 hour format.	05
hhmm	Shows the current hour and minute in two digit without a separator. Note: Displays the hour in 12 hour format.	0509
hhmmam pm	Shows the current hour and minute in two digit without a separator. It also displays, if the current hour is in am or pm. Note: Displays the hour in 12 hour format.	0509pm
hhmmalp	Shows the current hour and minute in two digit without a separator. It also shows, if the current hour is in am or pm by displaying a or p. Note: Displays the hour in 12 hour format.	0509p

Table 5-16: Time Format (Continued)

Field Name	Description	Example
hhmmss	Shows the current hour, minute and second in two digit without a separator. Note: Displays the hour in 12 hour format.	050919
hmm	Shows the current hour in single digit and minute in two digit without a separator. Note: Displays the hour in 12 hour format.	509
hmss	Shows the current hour and minute in single digit, and second in two digits without a separator. Note: Displays the hour in 12 hour format.	5909
ss	Shows the current second in two digit.	19

Table 5-16: Time Format (Continued)

Counter Field

Field Name	Description	Example
Counter Type	Allows the user to select the type of counter. <ul style="list-style-type: none"> Numeric Upper Case Alpha-betic Lower Case Alpha-betic 	<ul style="list-style-type: none"> Numeric: 5 Upper Case Alpha-betic: A Lower Case Alpha-betic: a
Counter Length	Allows the user to select the length of the counter. Note: Length of the counter must be within the range: <ul style="list-style-type: none"> 1 to 9 for Numeric 1 to 5 for Upper and Lower Case Alpha 	3
Start Value (0 - 999999999)	Allows the user to set the start value of the counter. Note: Start value of the counter depends on the counter type selected.	<ul style="list-style-type: none"> Numeric: 5 Upper Case Alpha: A Lower Case Alpha: a
End Value (0 - 999999999)	Allows the user to set the end value of the counter. Note: Start value of the counter depends on the counter type selected.	<ul style="list-style-type: none"> Numeric: 5 Upper Case Alpha: A Lower Case Alpha: z
Padding	Allows the user to select the option if the leading zeros or spaces are required before the start value. The user can select 'None', 'Space' or 'Leading Character'	If the counter length is 4 and option for pad with leading zeros is set as Yes, then the start value will be 0005.
Prints per Count	Allows the user to set the number of prints required per count.	1 - 999

Table 5-17: Counter Field

Field Name	Description	Example
Step Size	The number of units with which the counter increases or decreases. The size is a numerical value even for alphabetical counters (a value of 2 causes an alphabetical counter to count "a, c, e, g").	Minimum: 1 Maximum: 1000000 Default: 1
Rollover	Sets the counter to restart when the counter reaches end value.	If the start value of the counter is 1 and the end value is 9999, then the counter restarts with 0 after it reaches 9999.
Start Value Type	Start value can be set with either of the following option. <ul style="list-style-type: none"> • Default Value • Last Value • Prompt for Value 	<ul style="list-style-type: none"> • Default value - It is the value set by default. • Last Value - It is the last value of the previous counter. • Prompt for Value - Prompts the user to set the value.
Reset Source	Allows the user to set the source to None or External.	
Encryption	Select the encryption type	Arabic

Table 5-17: Counter Field (Continued)

Free Text Options

Field	Description	Example
Text	Allows the user to enter free text.	
User Editable	Allows the user to make the text field editable or non editable. The fields, Prompt, Maximum Length and Fixed Length are visible only when this option is set to Yes.	
Prompt	Allows the user to enter the text that will prompt the message selector on the information to enter text.	Enter Batch Code
Maximum Length	Maximum length of the user editable field.	
Fixed Length	Restricts the user entered field to a fixed length.	
Encryption	Allows the user to choose the type of encryption.	CLARiTY.Encryption.Arabic

Table 5-18: Free Text

To Edit a Message

Do the following tasks to edit and save a message:

- 1 Navigate to *Tools > Message Editor* from the *Home Page*.

- 2 Select the message which needs to be edited and touch .

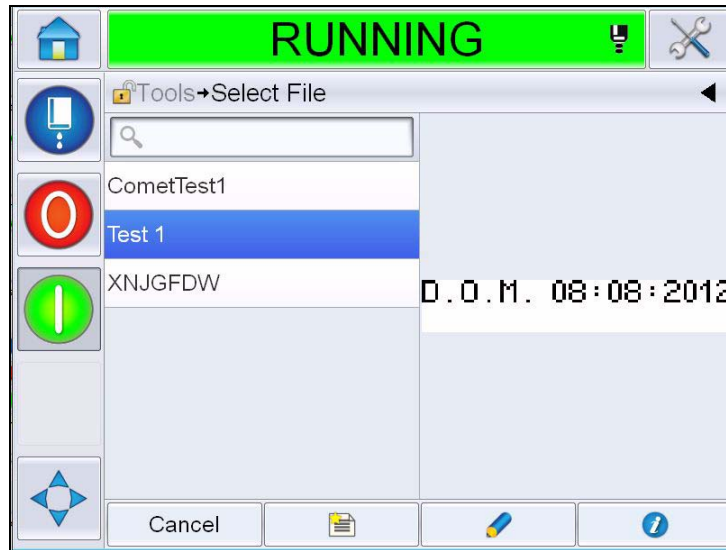

Figure 5-40: Edit Page

- 3 The message is displayed in the 'message page'.

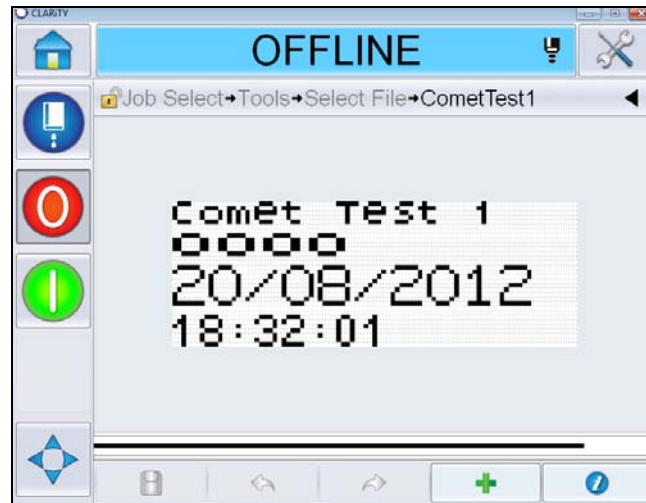





Figure 5-41: Message Page

- 4 In Message Page, there are three options:

- For adding a new user field, touch .
- For editing an existing user field, select a content (see “To Select Content” on page 5-54) and touch .
- For changing the message parameters:
 - Default Message Parameters: Navigate to *Tools > Setup > Control > Default Message Parameters*. For more details, refer “Default Message Parameters” on page 5-11 in Table 5-3.
 - Current Message Parameters: Touch  without selecting any user field in the message page and edit the parameters as required. For more information, see “To change Current Message Parameters” on page 5-68.

To Select Content

Click on the required field, a blue box appears around the selected field as shown in Figure 5-42 on page 5-54. Click a blank space anywhere in the message to deselect or click on another field as required.

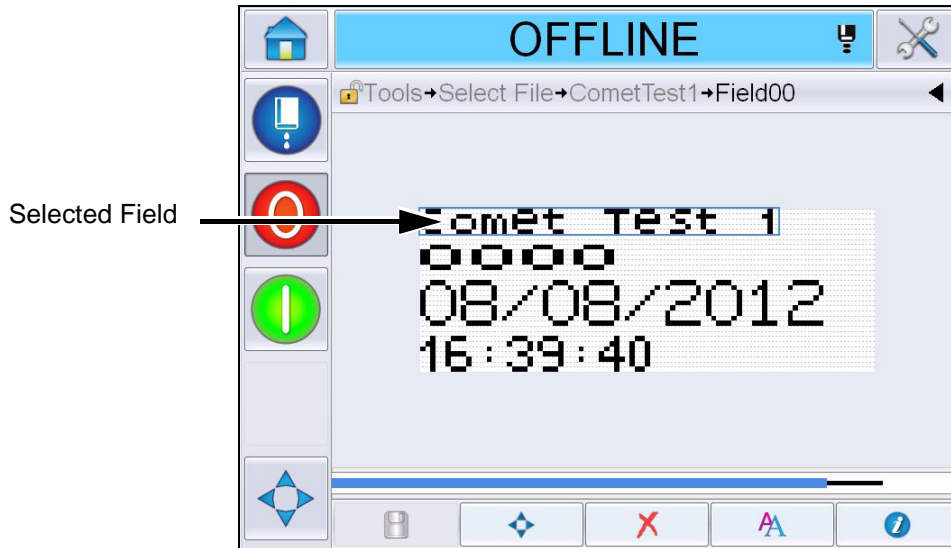



Figure 5-42: Selected Field

- 5 Touch  to edit the field properties.

Note: Touching the button without selecting a field will enable the user to view and edit the 'current message parameters'.

For viewing and editing the Default Message Parameters, navigate to *Tools > Setup > Control > Default Message Parameters*. For more details, refer "Default Message Parameters" on page 5-11 in Table 5-3.

- 6 Edit the required field property and touch *OK*.

Note: The field properties displayed depends on the selected field. For example, if a text field is selected for editing, the 'Free Text' field properties is displayed for editing.

To Enter Multiple Lines in a Message

Note: The printer automatically selects the best configuration from the message that you entered.

You can enter the messages that have a maximum height of 34 dots. You can enter multiple lines of text until all lines fit within the allowed height of the message space.

You can drag the fields by selecting and moving within the message space. Alternatively you can select arrow button (see Figure 5-43 on page 5-55) and move by selecting the required arrow (see Figure 5-44 on page 5-55).

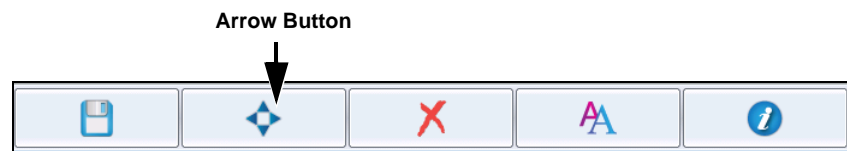

Figure 5-43: Message Editor Tool bar

Use the direction arrows to move the fields.



Figure 5-44: Arrow Tool bar

To Clear a Field in a Message

Do the following tasks to clear a field in a message:

- 7 Navigate to *Tools > Message Editor* from the *Home Page*.
- 8 Touch the message which needs to be edited and touch *Edit*.

- 9 Touch the required field to clear.

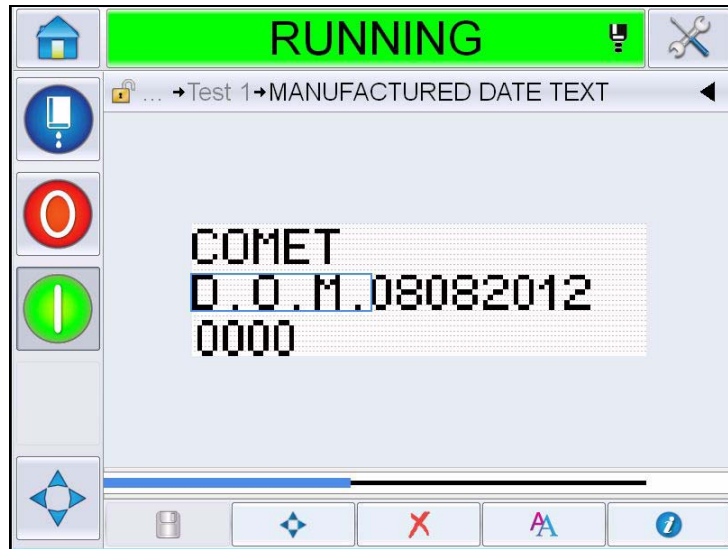



Figure 5-45: Select Field

- 10 Touch , the following screen appears. Displays the confirmation page.

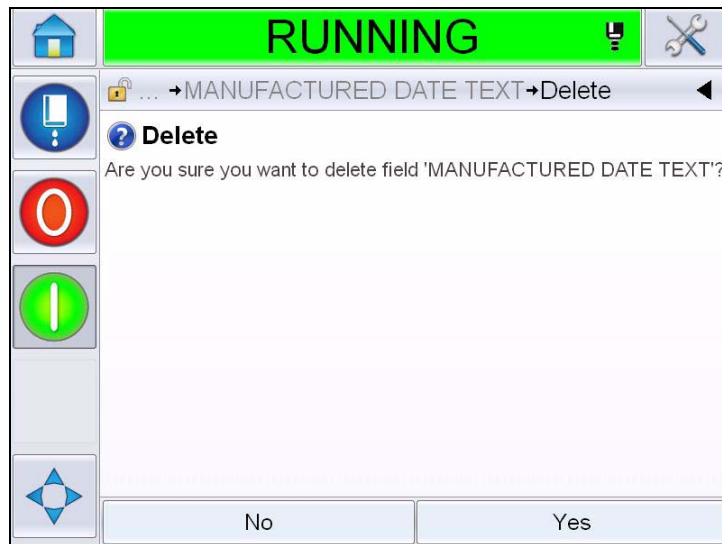

Figure 5-46: Confirmation Screen

- 11 Touch *Yes* to delete the selected field.

Note: It is recommended that you save the message with a unique reference.

- 12 Touch the  button. The field is deleted.



Figure 5-47: Message Cleared

To Modify Font Attributes

Do the following tasks to modify the font attributes:

- 13 Navigate to *Tools > Message Editor* from the *Home Page*.
- 14 Touch the required message and then touch *Edit*.
- 15 Touch the text field which needs to be modified.

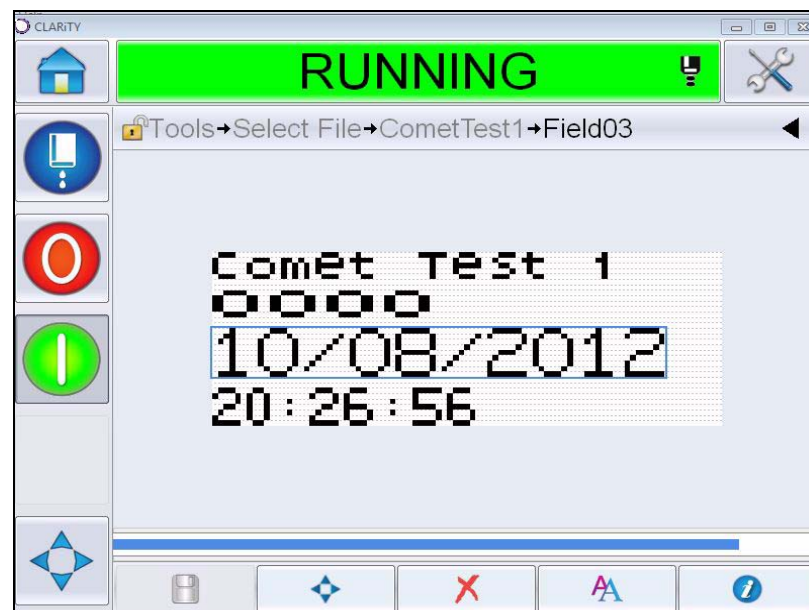



Figure 5-48: Select Text Field

16 Touch  button.

 icon navigates the user to the font attribute information which allows the user to access the font attributes or select the keys below for editing the font properties (See Table 5-19).





Key	Function
	Increases the font height for the selected field.
	Decreases the font height for the selected field.
	Make the selected field in Bold.
	Unbold the selected field.

Table 5-19: The keys to Change the Height of the Fonts

Note: Where a character is not available (for example, where the font is too small), it will be displayed with an asterisk (*) on the keypad.

17 Touch the  button and the list of available font properties appear.

18 Touch the suitable option and modify.

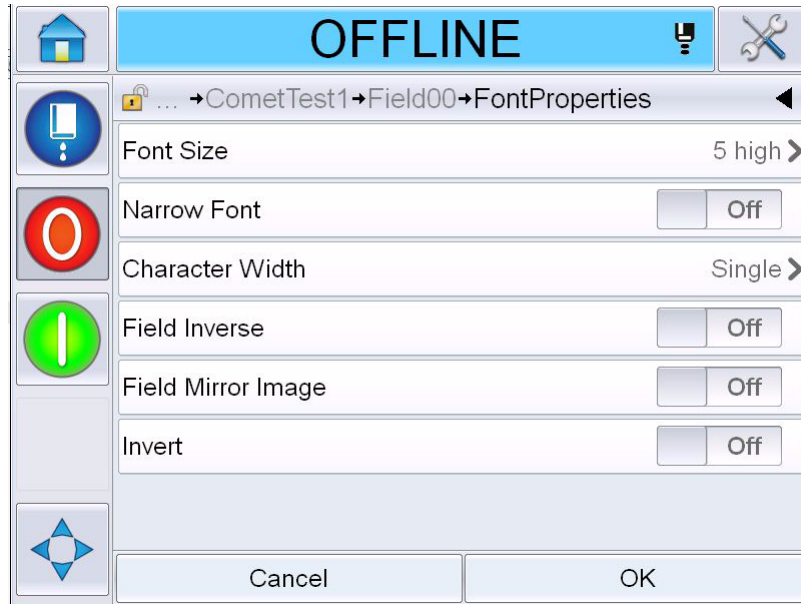

Figure 5-49: Font Properties List

Table 5-20 shows the various font properties:

Field	Options	Description
Font Size	5 high, 7 high, 9 high, 12 high, 16 high, 24 high and 34 high	Allows the user to choose between various font sizes.
Narrow Font	On, Off	Allows the user to set the Narrow Font option <i>On/Off</i> .
Character Width	Single, Double, Triple	Allows the user to set the width of the character as <i>Single/Double/Triple</i> .
Field Inverse	On, Off	Allows the user to set the Field Inverse option <i>On/Off</i> . Setting this to 'On' will invert the font colour.
Field Mirror Image	On, Off	Allows the user to set the Field Mirror Image option <i>On/Off</i> . Setting this to 'On' will mirror the field.

Table 5-20: Font Properties

Field	Options	Description
Invert	On, Off	Allows the user to set the Invert option <i>On/Off</i> . Setting this to 'On' will invert the field.

Table 5-20: Font Properties (Continued)

19 Touch OK button.

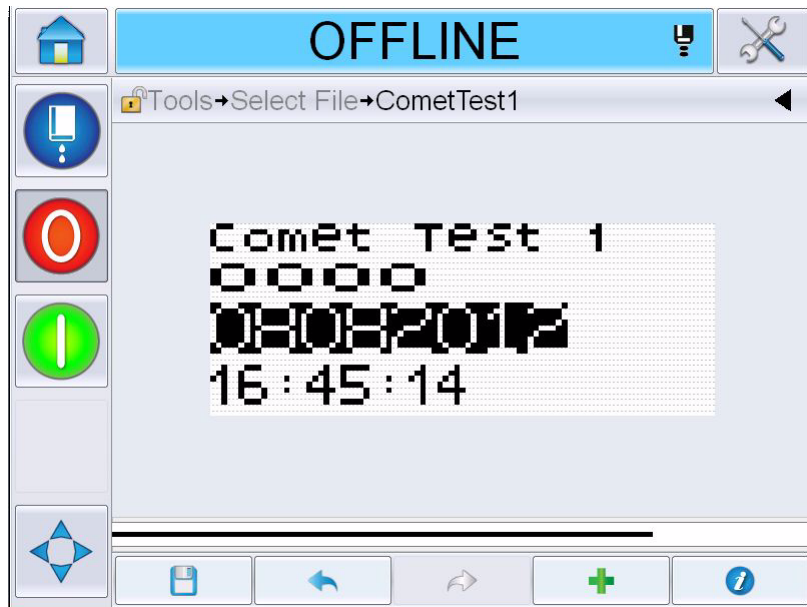

Figure 5-50: Modified Text Screen

20 After editing the message, Touch the save button



- 21 Modify the name if required, else touch *OK*. Displays the confirmation Page.

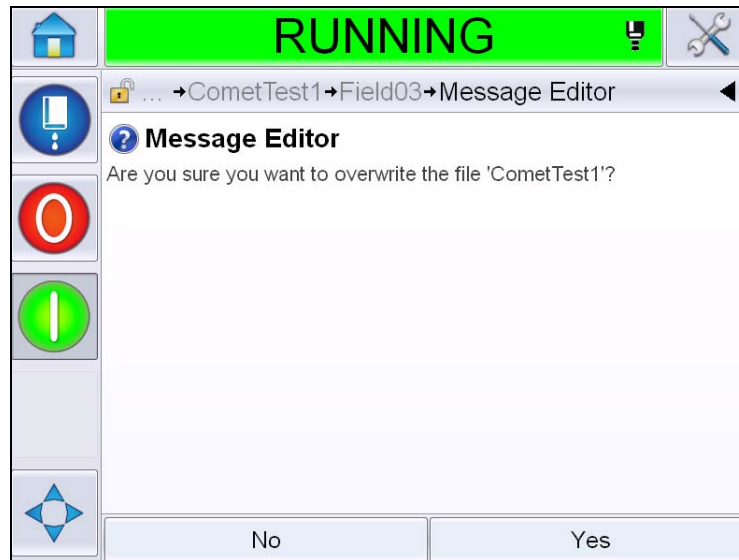

Figure 5-51: Edit Page

Note: It is recommended that you save the message with a unique reference.

- 22 Touch *Yes* to save the edited message.

Note: Always reload a message when a change is made to either a message or message parameters. The only time this is not required is when the change is made after pressing the nudge button on the home page.

Note: To exit the Message Editor without saving the message, touch Home or Tools button.

To Delete a Message

Do the following tasks to delete a message:

- 1 Navigate to *Tools > Databases > Internal* from the *Home Page*.
- 2 Touch *Edit*.

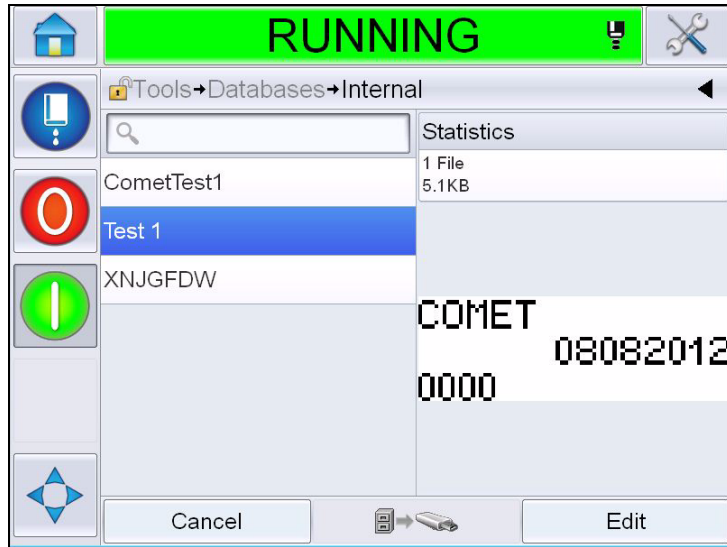

Figure 5-52: Internal Screen

- 3 Select the message which needs to be deleted and touch *Delete*.

Note: You can touch *Select All* to delete all the available messages.

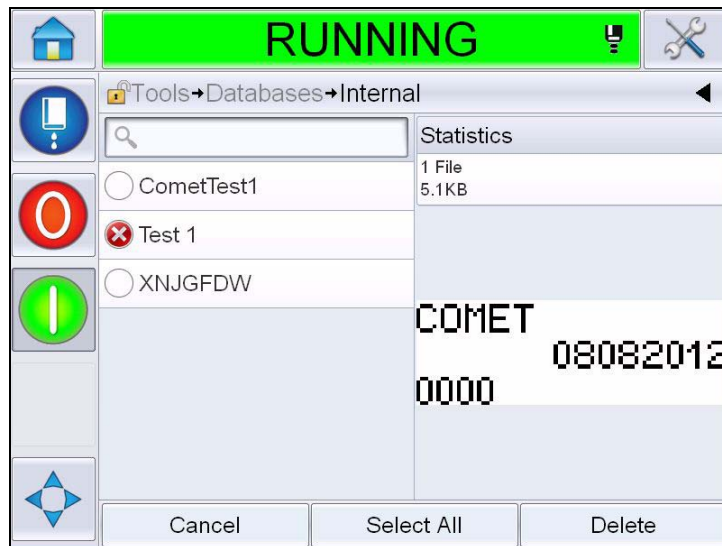

Figure 5-53: Delete Screen

- 4 Displays the *confirmation page*.

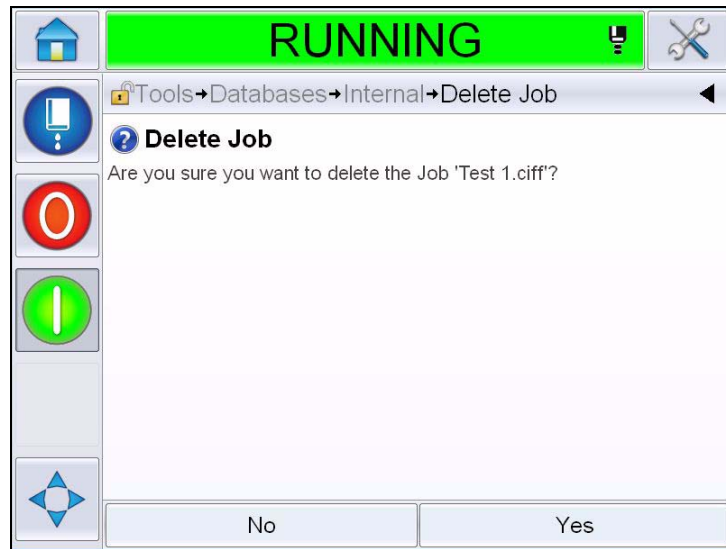

Figure 5-54: Confirmation Screen

- 5 Touch *Yes* to confirm the deletion.

To Define a Prompted Field

Prompted fields define the content that can change each time the message is used. The content can include a message of the day or other content that is related to a known run of the product, but remains the same for that complete run.

When a message that contains a prompted field is loaded, the operator is asked to provide the contents for the field.

Do the following tasks to define a prompted field:

- 1 Follow the steps 1 to 3 under the section “To Create a Message” on page 5-30.

- 2 Add a free text field. Refer the steps 14 and 15 under the section “To Add Free Text” on page 5-38.

Note: The user editable option is available on all the user fields.

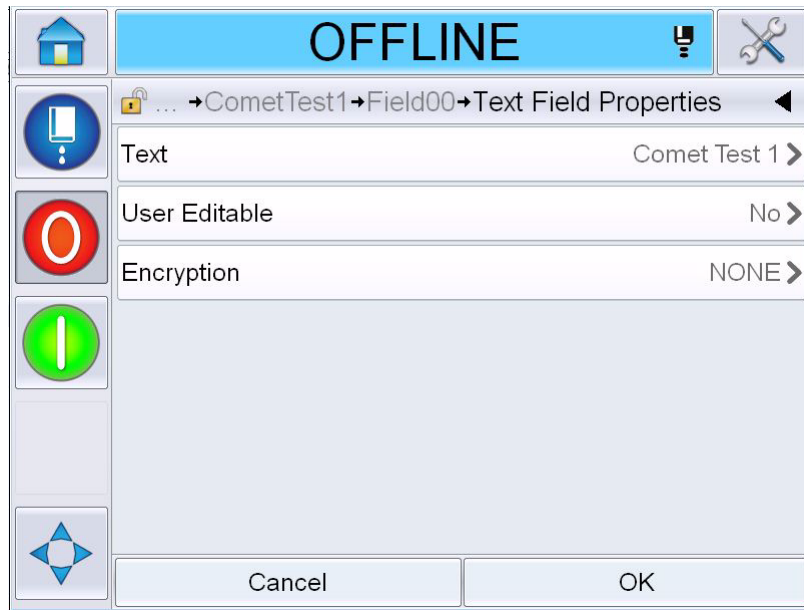

Figure 5-55: Text Field Properties Screen

- 3 Touch *User Editable* and select *Yes*. A list of additional fields appear (see Figure 5-56).

Note: The user editable option is set to 'No' by default. If this is changed to 'Yes' the user can set the prompt text, field length and encryption. The prompt text becomes the user field name.

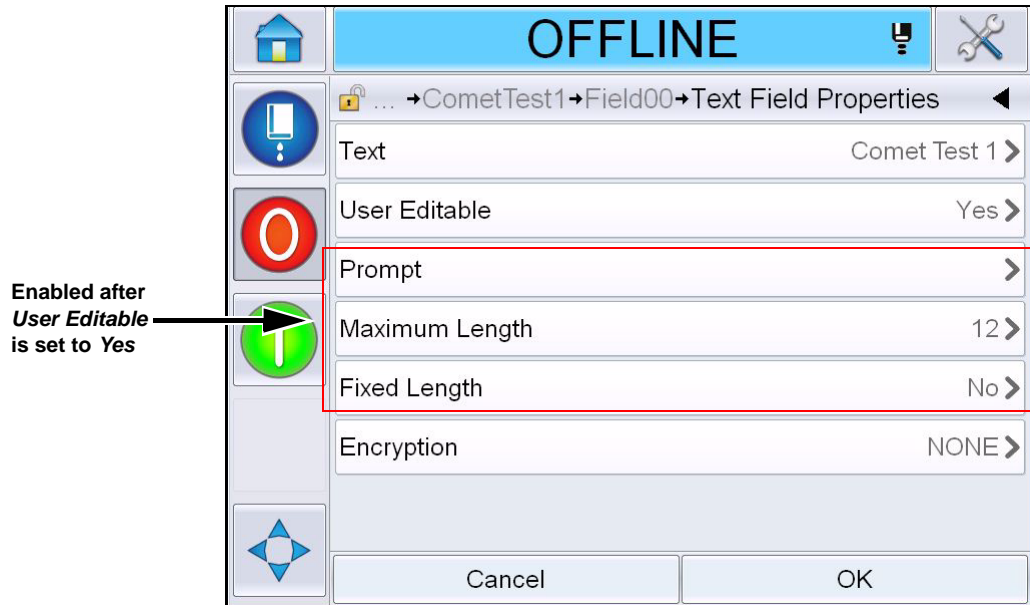

Figure 5-56: Additional Text Field Properties Screen

- 4 Set the maximum length and fixed length.

- 5 Enter the prompt for the field in the QWERTY page. This will be the prompt when the message is selected.



Figure 5-57: Prompt Screen

- 6 Touch OK.

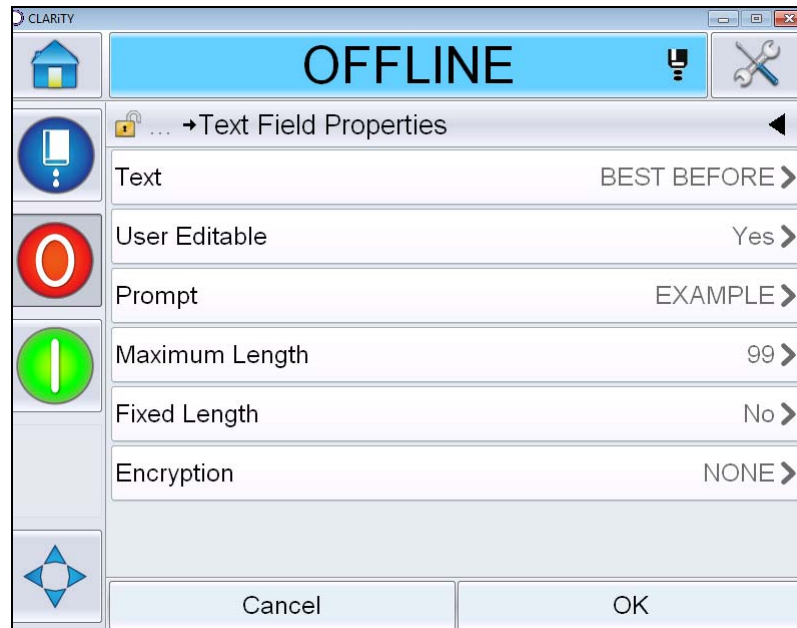

Figure 5-58: Text field properties

- 7 Touch OK and save the message after entering the message name.

- When this message is selected by navigating to *Home > Job Select*, the user interface will display this prompt. Touch *Edit* to change the content of the prompted field.

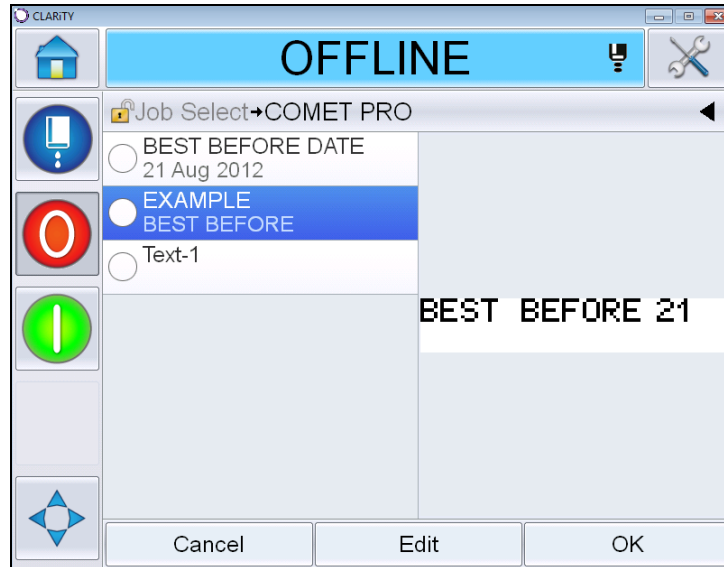

Figure 5-59: Prompt

Note: Additional user fields can be set up using CLARiSOFT®.

To add logo

Logos are setup in CLARiSOFT®.

To Insert a Barcode

Barcodes will be setup in CLARiSOFT®.

To change Current Message Parameters

In the message page, touch  without selecting any user field. Displays the following screen. Edit the parameters as required.

Note: These parameters will only apply to the current message. For changing the default parameters, see “Default Message Parameters” on page 5-11.



Figure 5-60: Current Message Parameters

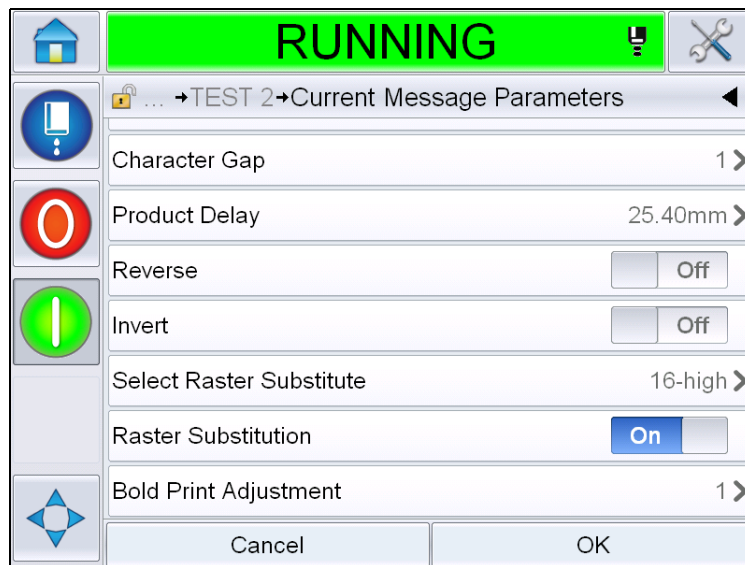

Figure 5-61: Current Message Parameters 2

Parameter	Description
Width	Allows the user to set the required message width.
Character Height	Allows the user to set the required character height.
Character Gap	Allows the user to set the required message character gaps.
Product Delay	Allows the user to set the product delay (the time between the start of product (trigger point) and the print start position).
Reverse	Reversed (back to front) character printing.
Invert:	Inverted (upside down) character printing.
Select Raster Substitute	Lists the file name of the selected raster.
Raster Substitution	When selected ON the printer automatically selects the appropriate raster for the line running speed.
Bold Print Adjustment	Sets the value for Bold Print Adjustment.

Table 5-21: Current Message Parameters

Import Messages

Do the following tasks to import messages:

- 1 Navigate to *Tools > Databases* from the *Home Page*.



Figure 5-62: Databases

Note: This option is available only when the USB memory stick containing the folder *JOBS* is inserted to the USB port.

Note: The messages to be imported (.CIFF files) must be located within the *JOBS* folder in the USB.

- 2 Touch *External*. List of available messages in the USB will be displayed.

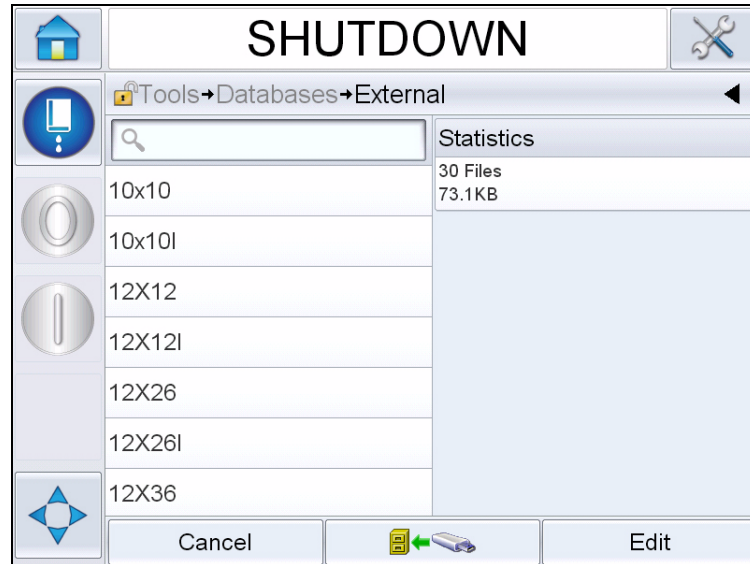



Figure 5-63: Messages in USB

- 3 Select a message to be transferred to the printer and touch . Displays the confirmation page.
- 4 Touch *Yes* to continue or *No* to return to the external database message screen.
- 5 Now the message is imported successfully. Touch *OK* to return to external database message screen.

Export Messages

Do the following tasks to export messages:

- 1 Navigate to *Tools > Databases > Internal* from the *Home Page*. Displays the list of messages available in the printer.

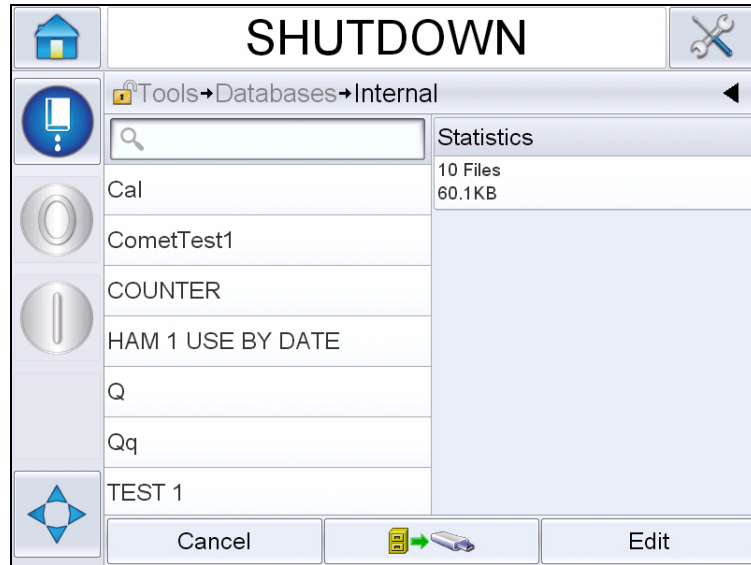



Figure 5-64: Messages in Printer

- 2 Select a message to be transferred to the USB and touch . Displays the confirmation page.
- 3 Touch *Yes* to continue or *No* to return to the internal database message screen.
- 4 Now the message is exported successfully. Touch *OK* to return to internal database message screen.

Overall Equipment Effectiveness - Availability Tools

Introduction

Availability is a measurement of equipment uptime. It is the amount of time that the equipment is ready to run when required by production. This is one of the three key metrics of OEE and is available for Videojet 1560.

The 'Availability' tool helps to isolate operational versus printer issues and allows the user to track the printer downtime and view the downtime statistics. The pareto of faults that allows the analysis of runtime measurement data helps the user to understand and eliminate the more frequent causes of both printer and operational downtime.

The availability shows two basic availability metrics simultaneously:

- Printer Availability
- Operational Availability

***Note:** Operational Availability can be changed between two separate production time proxies as required by the user: "power on" and "jets on" mode. For more information, refer "Operational Availability" on page 5-74.*

$$\text{Availability\%} = \frac{\text{Operating Time}}{\text{Planned Production Time}}$$

Where

- Operating Time is Total Printer Uptime
- Planned Production Time is the Actual Line Run Time Expected*.

*Based on proxy selected 'power on' or 'jets on'.

Printer Availability

Printer Availability tracks the downtime directly related to an internal error (fault) such as

- Pump Failure
- Charge Supply Fault
- Gutter Fault

Printer Availability is defined as

$$\text{Printer Availability} = 1 - \frac{\text{Printer Downtime}}{\text{Printer Total Time}}$$

'Printer Total Time' is the total amount of time for which the printer is turned on (has power applied). If the printer is powered down when a fault is active, the amount of time that the printer is off is also included in this printer total time.

'Printer Downtime' is the amount of 'Printer Total Time' the printer has spent in a 'Printer Fault State'. 'Printer Fault state' is defined as the period where the printer is not available due to a fault identified as a printer fault. For more information, refer Service Manual.

Operational Availability

This is a broader measure to reflect the full impact of the down time to production line. Operational Availability tracks the downtime related to faults that might be classed as "Procedural" such as:

- Core empty
- Head Cover removed
- Core Service Overdue.

The impact may be due to printer issues, operator related issues, shift changeovers and so on.

Operational Availability is defined as

$$\text{Operational Availability} = 1 - \frac{\text{Operation Downtime}}{\text{Production Time}}$$

The Production Time Proxy allows the availability calculation to change between customer selected operating modes, jets-on or printer-on. The production time is defined based on the production time proxy chosen:

- Jets On: If both printer and jet are switched ON.
- Power On: If the printer is switched ON irrespective of the status of the jet.

If the printer is powered down when a fault is active, the amount of time that the printer is off is also included in the production time.

'Operation Downtime' is the amount of 'Production Time' the printer has spent in an 'Operation Fault State'. 'Operational Fault state' is defined as the period where the printer is not available due to a fault identified as a operational fault.

Note: Refer Service Manual for further information on printer and operation fault states.

Availability Page

Touch *Performance* on the *Home* page.



Figure 5-65: Home Page

Displays the *Performance* Page. Touch *Availability* to access the availability page.



Figure 5-66: Performance Page

Displays the *Availability* page (see Figure 5-67). The user can view simultaneously the printer availability and operational availability data against the time frame. The history of the availability data in the Timeframe column enables the user to correlate seasonal changes affecting availability.

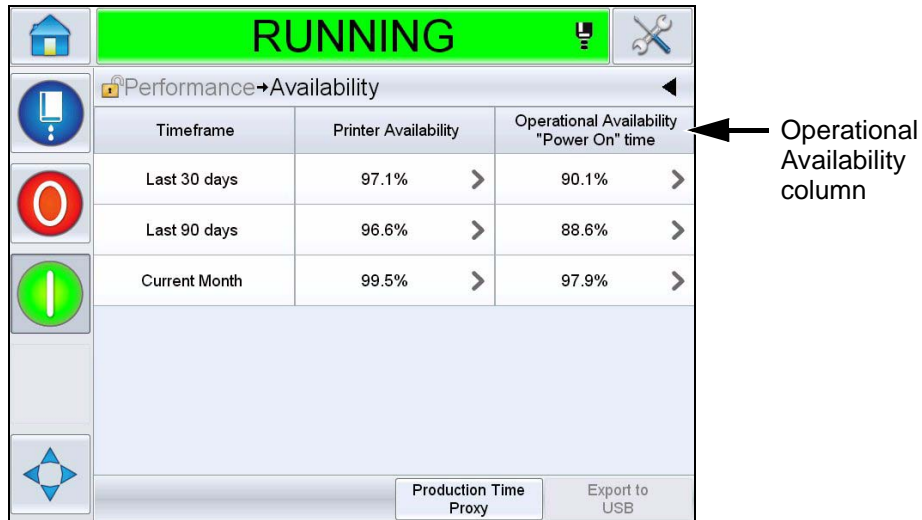

Figure 5-67: Availability

Note: Arrows shown in the availability cells indicates the presence of data for drilling down. Select the cell to view the specific data for detailed analysis.

Option	Description
Timeframe	Allows the user to view printer and operational availability values for different available time frames. The history of the availability data enables the user to correlate seasonal changes affecting availability.
Printer Availability	Shows the printer availability data.
Operational Availability	Shows the operational availability data based on the proxy in use for the calculation, that is "Power On" time or "Jets On" time
Production Time Proxy	Allows printer availability calculation to change between user selected operating modes that is either 'jets-on' or 'printer-on' mode. Proxy choice ensures the calculation of availability matches the operating mode of user. The operational availability column in the <i>Availability</i> page (see Figure 5-67) shows the proxy selected by the user.

Table 5-22: Availability Page options

Option	Description
Export to USB	Allows the user to export the event log to USB stick. The UI will take the user through the steps required to download to USB.
	Shows that further information is available. Touch the cell to view the <i>Fault Pareto</i> page for the selected availability data. The page displays the fault type, downtime and fault frequency (see Figure 5-68 and Figure 5-69)

Table 5-22: Availability Page options (Continued)



Figure 5-68: Fault Pareto for Printer Availability



Figure 5-69: Fault Pareto for Operational Availability

Option	Description
Fault type	Description of the error code and fault. Touch the fault type to view the detailed description of the fault and possible solutions.
Downtime	The total duration of time the printer was in this fault state.
Frequency	The number of times the printer had this fault in the time frame.
	
Sort By	Allows the user to sort the list based on printer downtime or fault frequency.
	
Change Time-frame	Allows the user to view fault pareto page for different available time frames.

Table 5-23: Fault Pareto



Option	Description
	
Printer/Operational Availability	Allows the user to toggle between printer and operational availability fault pareto page.

Table 5-23: Fault Pareto (Continued)

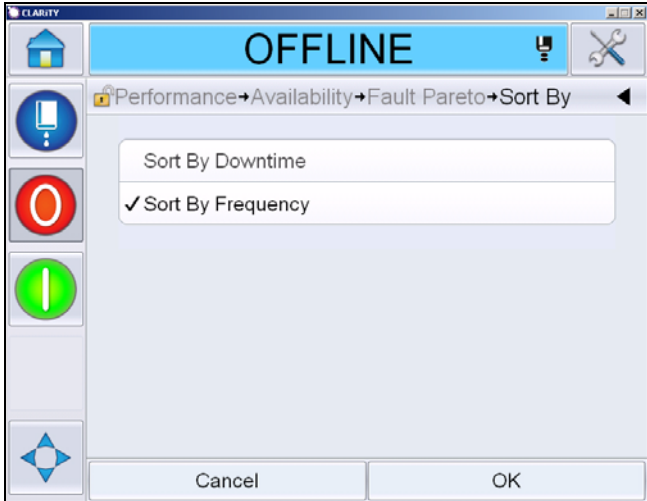
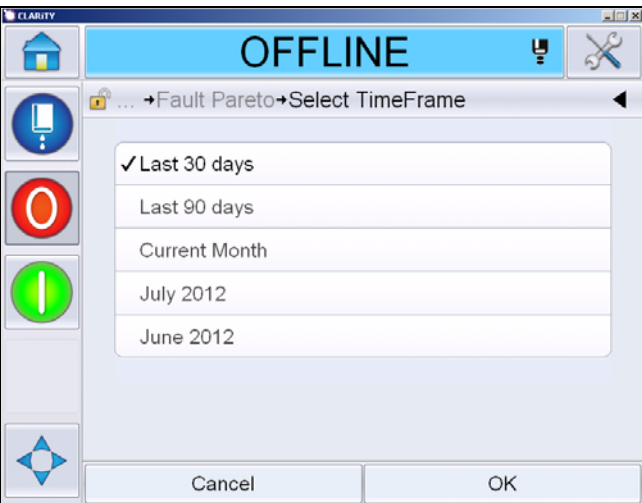
Touch  to view the *Event* page (see Figure 5-70). Event page displays the date, time and duration of each occurrence of that specific fault. This page can be used to correlate the occurrence of a fault with other events in the production facility.

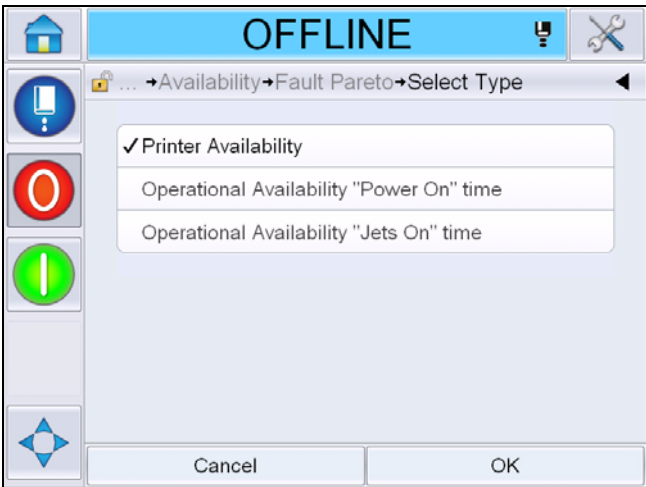

Current Month : (E6044) Head Cover Removed			
Date	Time	Duration (mmm:ss)	
05/11/2012	10:30	8:03	>
05/11/2012	10:27	0:11	>
05/11/2012	10:26	0:27	>
05/11/2012	10:25	0:04	>
05/11/2012	10:24	0:06	>

Figure 5-70: Event

Touch  to view the *Parameter* page (see Figure 5-71). Parameter page displays the detailed printer health parameters logged when the specific fault occurred.



Parameter	Event Time	1 min before	5 min before
Target Pressure	2.59bar	2.59bar	2.59bar
Temperature Compensated Target Pressure	2.58bar	2.58bar	2.60bar
Actual Pressure	2.58bar	2.59bar	2.57bar
Head Temperature	35.1°	35.2°	33.3°
Nozzle Temperature	33.6°	33.7°	31.2°

Figure 5-71: Parameter

Event Time: It is the time when the fault occurred.

Data is shown for 1 minute and 5 minutes prior to the event to illustrate data trends.

The printer highlights the parameters which are out of range. Combining this information to all noted symptoms can expedite root cause analysis.

Touch **Go to Event Log** to view *Event log* page (see Figure 5-72). You can also view this page by navigating through *Tools > Diagnostics > Printhead*.

The Event log retains all activities happening for 180 days period. It can be useful to check other printer activities occurring at the same time as a fault to understand the fault context.

You can filter to remove status, warnings, alarms as required.

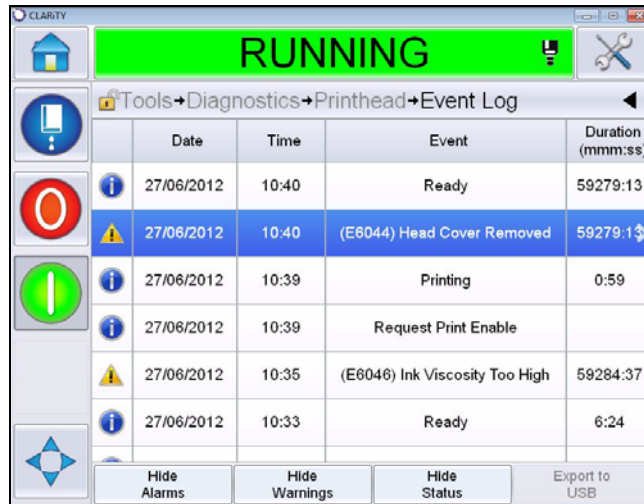

Figure 5-72: Event log

Symbol	Type
	Alarm event.
	Warning events.
	Status- a printer event where no warnings or alarms are raised.

Table 5-24: Event Log symbols

Note: If an event has caused downtime then the symbol will be present

along with the Alarm, Warning or Status symbols indicating that you can view the printer parameters at the time of that event.

Option	Description
Hide Alarms	Allows the user to Show/Hide any alarm events from the event log list.
Hide Warnings	Allows the user to Show/Hide any warning events from the event log list.
Hide Status	Allows the user to Show/Hide any status events from the event log list.
Export to USB	Allows the user to export the event log and associated parameter snapshots to USB stick. The UI will take the user through the steps required to download to USB.

Table 5-25: Event Log Page Option

Touch on the event message for detailed description of the fault or warning event. The user interface displays a detailed description, likely cause and resolution.

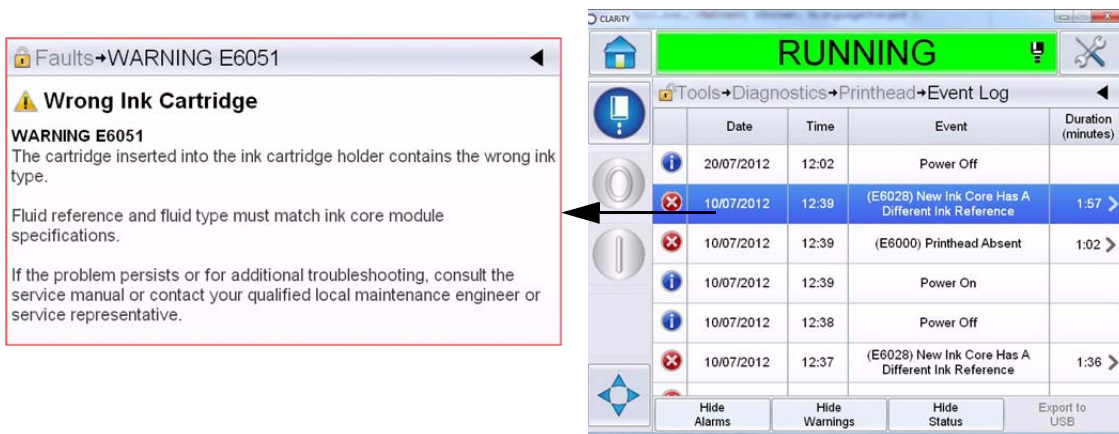

Figure 5-73: Event log diagnostics

	A	B	C	D	E	F	G
1	Event Id	Date	Time	Event Type	Event	Duration (minutes)	
2	16	19/09/2012	13:07:11	INFO	System time has changed		
3	15	19/09/2012	14:07:16	INFO	System time is changing...		
4	14	19/09/2012	14:06:46	FAULT	(E6033) Incompatible Raster Found	1.15	
5	13	19/09/2012	14:04:17	INFO	System time has changed		
6	12	19/09/2012	13:04:24	INFO	System time is changing...		
7	11	19/09/2012	13:03:43	WARNING	(E6044) Head Cover Removed	1.97	
8	10	19/09/2012	13:00:07	WARNING	(E6092) Charge Output Not Trimmable	12.38	
9	9	19/09/2012	12:57:55	INFO	Message Select		
10	8	19/09/2012	12:57:55	WARNING	(E6082) Charge DAC not zeroed	2.2	
11	7	19/09/2012	12:57:55	WARNING	(E6061) Make-Up Insertions Exceeded	14.58	
12	6	19/09/2012	12:57:55	WARNING	(E6003) Make-up Cartridge Expired	14.58	
13	5	19/09/2012	12:57:55	WARNING	(E6055) Ink Insertions Exceeded	14.58	
14	4	19/09/2012	12:57:55	WARNING	(E6002) Ink Cartridge Expired	14.58	
15	3	19/09/2012	12:57:54	INFO	Power On		
16	2	19/09/2012	12:57:15	INFO	Power Off		
17	1	19/09/2012	12:56:37	INFO	Power On		

Figure 5-74: Exported Data

For more information on the exported data, refer the Service Manual.

Introduction

The maintenance of the printer includes the procedures that an operator or a service technician can perform. This chapter describes the maintenance tasks that the operators of the printer are allowed to perform. The other maintenance tasks that only the trained service technicians and personnel must perform are described in the Service Manual.



Warning

PERSONAL INJURY. It is possible that in a fault condition, the heater can reach 70° C. Do not touch the plate on which the heater is installed. The failure to follow this warning can cause personal injury.

Maintenance Schedule

Table 6-1 shows the maintenance schedule.

Interval	Task
When the printer is commissioned or if the make-up cartridges are empty	Replace the smart cartridge. Refer "Replace Smart Cartridges" on page 6-4.
As Required	Clean the following parts of the printhead: <ul style="list-style-type: none"> • Deflector Plate • Gutter Note: Check the quality of the print before you do the maintenance. Refer "Inspect the Printhead" on page 6-7, and "Clean the Printhead" on page 6-7.
	Clean the printer cabinet.
	Clean the Touch Screens
Every 2000 Hours	Replace the back filter.

Table 6-1: Maintenance Schedule

Preparation for Long-term Shutdown (Storage) or Transportation

Note: Long term Shutdown procedure should be used when the printer will not be used for more than three months.

Parts/tools Requirement

Parts/Tool	Quantity	Part Number
Make-up Cartridges matching existing make-up in ink core which will be flushed	4	-
Empty Cartridges	6	SP399246
Nozzle Bypass Manifold (Loop Connector) Kit with gasket	1	399247

Table 6-2: Parts and Tools

How to Prepare for Long-term Shutdown (Storage) or Transportation

Do the following tasks to prepare the printer for long-term shutdown/transportation:

- 1 Perform a Clean Stop.
- 2 Run three nozzle flushes.
- 3 Remove the Nozzle Manifold, and attach the Nozzle Bypass Manifold (with gasket) to it. Perform Empty Core Procedure.

Note: Printhead needs to be placed over a wash station or a suitable container to capture any overspill.

- 4 After core procedure completes, run the *Flush Ink Core* procedure and follow the printer instructions.

Note: The total time to complete this process is approximately three hours. It will require four sets of cartridges, each cartridge set is attached for 30 to 45 minutes. Each set, upon completion, will be half full with mixed fluids.

- 5 Remove the Nozzle Bypass Manifold and fix the Nozzle Manifold with the gasket from the print engine deck.

The printer is now ready for storage or transportation.

Note: When the ink core has been refilled with the ink removed for storage, do not recalibrate viscosity on re-install as the calibration data has been saved.

Note: While preparing the printer for long term shut down, for manufacturer password, please contact Videojet Technologies Inc. at 1-800-843-3610 (for all customers within the United States). Outside the U.S., you should contact your Videojet Technologies Inc. distributor or subsidiary for assistance. Alternatively, you can visit www.videojet.com > Support > Videojet Password Generator.

Replace Smart Cartridges

There are two types of smart cartridges:

- Ink cartridge
- Make-up fluid cartridge

The user has to install the cartridges when the printer is commissioned or when the cartridges are empty. The type of fluid (ink or make-up fluid) is written on the cartridge labels.

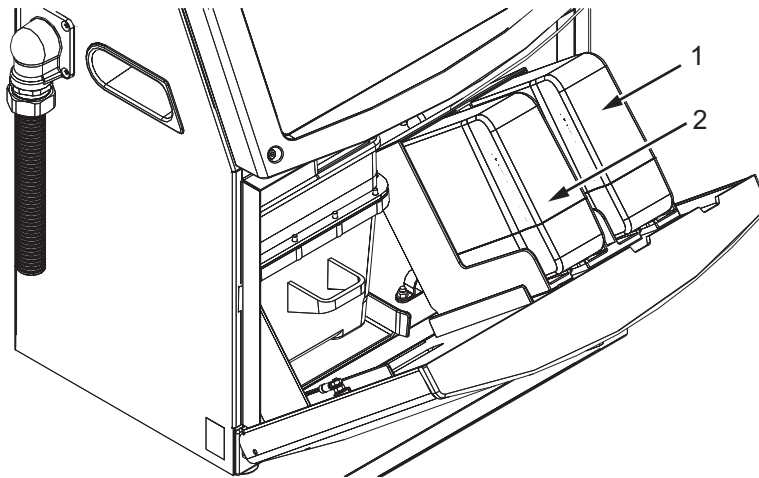

1. Ink Cartridge
2. Make-up Fluid Cartridge

Figure 6-1: Smart Cartridges

To add or replace the cartridges, do the following tasks:

- 1 Open the door of the ink compartment, and keep the door in the position shown in the Figure 6-1.
- 2 If the ink or make-up fluid cartridge indicators indicate 0% and an error indicates that the ink and/or make-up fluid cartridges are empty, go to step 4.
- 3 If the ink or make-up fluid cartridge is not loaded a warning appears asking for the required cartridge to be inserted, go to step 5.

Warning

PERSONAL INJURY. All fluids like the ink, solvent and make-up fluid are volatile and flammable. They must be stored and handled according to the local regulations. Work only in areas with good ventilation. The cleaning solution is poisonous if taken internally. Do not drink. Seek medical attention immediately if ingested.

- 4 Pull the old ink cartridge (item 1, Figure 6-2) and the old make-up fluid cartridge (item 2) out of the printer cabinet.

Note: Shake the ink cartridge before inserting it into the printer.

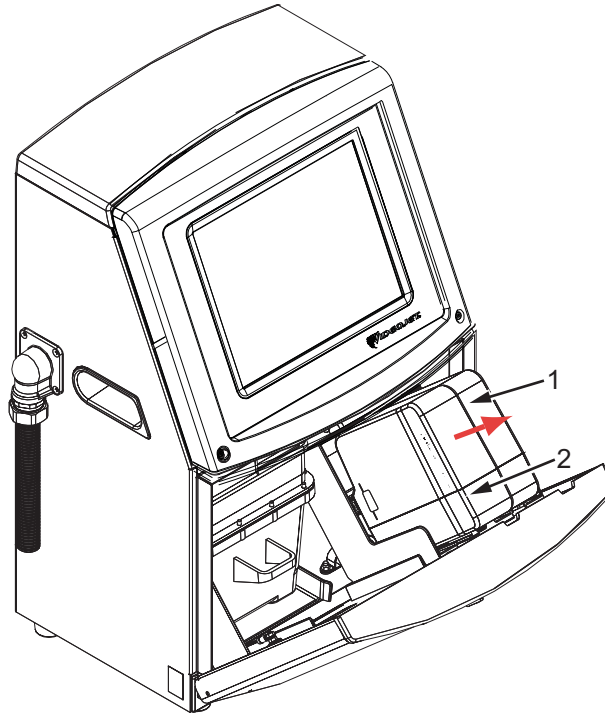

1. Ink Cartridge
2. Make-up Fluid Cartridge

Figure 6-2: Pull out the Cartridges

- 5 Insert the new ink cartridge into the ink cartridge holder by aligning the cartridge key with the correct holder slot (see Figure 6-3 on page 6-6).
 - a. Make sure that the cartridge is engaged completely in the holder.

Note: Push the cartridge until the cartridge locks into the cartridge holder (that is till you hear a snap sound).

- b. Make sure that the warning that indicates “ink cartridge not loaded” disappears. The warning can take some seconds to disappear.

- c. Make sure that the cartridge level indicator shows 100% full.

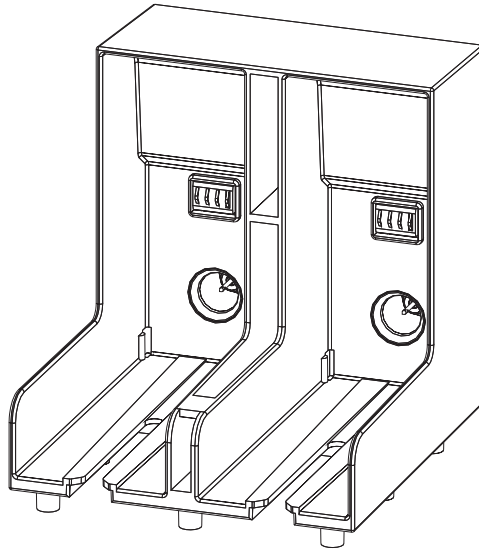

Figure 6-3: Cartridge Holder Slot

- 6 Insert the new make-up fluid cartridge into the make-up fluid cartridge holder by aligning the cartridge key with the correct holder slot.
 - a. Make sure that the cartridge is engaged completely on the holder.
 - b. Make sure that the warning that indicates “make-up fluid cartridge not loaded” disappears. The warning can take some seconds to disappear.
 - c. Make sure that the cartridge level indicator shows 100% full.

Inspect the Printhead

Do the following tasks to inspect the printhead:

- 1 Stop the ink jet and wait for the printer to completely shutdown.
- 2 Disconnect the printer from the power supply.
- 3 Loosen the printhead screw (item 2, Figure 6-4 on page 6-9) and remove the printhead cover (item 3).
- 4 Inspect the printhead and the inside of the printhead cover for any ink deposits. Clean if necessary (refer "Clean the Printhead" on page 6-7).

Clean the Printhead



Warning

PERSONAL INJURY. In the event of an ink or solvent spill, leakage from the printer could cause a floor/slip hazard and/or fire hazard (particularly if the equipment is situated over flammable material and/or other equipment). An optional drip tray is available (Part Number 234407). To install, place the drip tray on surface that the printer is to be used. Place the printer in the centre of the drip tray. Ensure that the drip tray is appropriately grounded to avoid static build up.



Warning

VAPOUR HAZARD. Prolonged breathing of cleaning solution vapor can cause drowsiness and/or effects like alcoholic intoxication. Use only in well ventilated, open areas.



Warning

HANDLING CLEANING SOLUTION. The cleaning solution is irritating to the eyes and respiratory system. To prevent personal injury when handling this substance:

Always wear protective rubber gloves and clothing.

Always wear goggles with side-shields or a face mask. It is also advisable to wear safety glasses when carrying out maintenance.

Apply barrier hand cream before handling ink.

If cleaning solution contaminates the skin, rinse off with running water for at least 15 minutes.



Warning

FIRE AND HEALTH HAZARD. The cleaning solution is volatile and flammable. It must be stored and handled in accordance with local regulations.

Do not smoke or use a naked flame in the vicinity of the cleaning solution.

Immediately after use remove any tissues or cloth that are saturated with cleaning solution. Dispose off all such items in accordance with local regulations.



Caution

EQUIPMENT DAMAGE. To prevent the damage to the printer components, use only soft brushes and lint free cloths to clean the printer. Do not use high-pressure air, cotton waste or abrasive materials.



Caution

EQUIPMENT DAMAGE. Make sure that the cleaning solution is compatible with the ink used before you clean the printhead. The failure to follow the caution can damage the printer.

Note: Make sure that the jet is turned off.

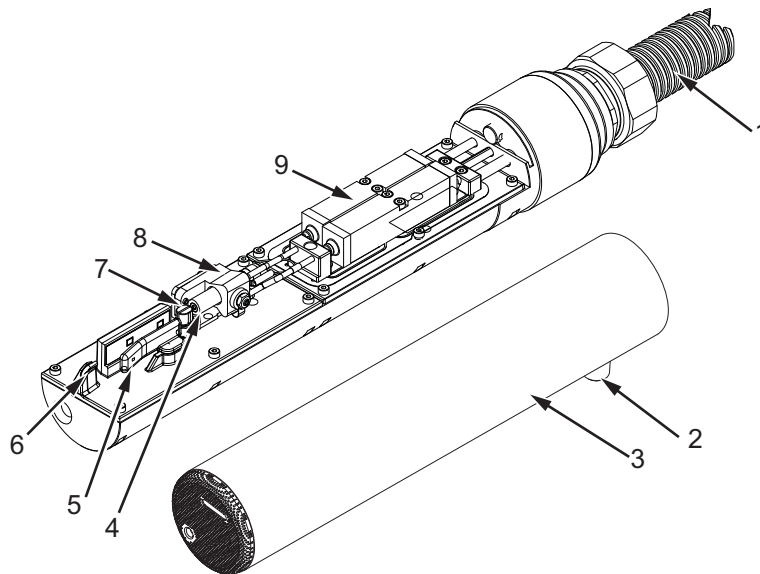

- | | |
|--------------------|---------------------------|
| 1. Umbilical | 6. Gutter Sensing Tube |
| 2. Printhead Screw | 7. Charge Electrode |
| 3. Printhead Cover | 8. Printhead Engine |
| 4. Nozzle | 9. Printhead Valve Module |
| 5. Deflector Plate | |

Figure 6-4: Printhead

- 1 Put the printhead into the wash station (part number 399085).
- 2 Use a cleaning agent and a tissue or a soft brush to clean the following parts of the printhead:
 - Gutter Sensing Tube (item 6, Figure 6-4)
 - Charge electrode (item 7)
 - Deflector plate (item 5) (see “Clean the Deflector Plate” on page 6-10)
 - Nozzle (item 4)

Note: The cleaning agent must be compatible with the type of ink that you use in the printer.

- 3 Allow the printhead to dry and make sure that the slot in the charge electrode is free of cleaning agent.

Note: Use a hand blower or compressed air to dry the printhead quickly. The air pressure must not be more than 20 psi.

 **Caution**

EQUIPMENT DAMAGE. The printhead must be dry before you try to start the printer. The failure to follow this caution can damage the printhead.

- 4 Refit the printhead cover and tighten the knurled screw.

Clean the Deflector Plate

To prevent the deposits of ink, clean the contoured surfaces of the deflector plate with the solvent, and clean dry air (CDA).

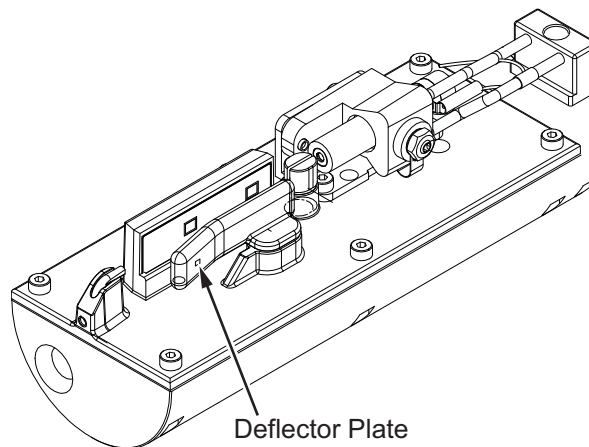

Figure 6-5: Clean the Deflector Plate

Clean the Printer Cabinet

To clean the printer cabinet, do the following tasks:



Warning

PERSONAL INJURY. Airborne particles and materials are a health hazard. Do not use high-pressure compressed air to clean the printer cabinet.



Caution

EQUIPMENT DAMAGE. Any cleaning solutions containing either chloride, including hypochlorite bleaches or hydrochloric acid, can cause unacceptable surface pitting and staining. These should not be used in contact with stainless steels. If wire brushes or wire scouring pads are used, these should be made of stainless steel. Make sure that any abrasive media used is free from sources of contamination, especially iron and chlorides.

- 1 Remove the dust from the printer with a vacuum cleaner, or soft brush.
- 2 Clean the outer surfaces of the printer with a wet lint free cloth.

Use a mild detergent to remove the contamination that you cannot remove by a wet cloth.



Warning

To avoid damage to the printer components, use only soft brushes and lint free cloths for cleaning. Do not use high pressure air, cotton waste, or abrasive materials.



Caution

EQUIPMENT DAMAGE. Any cleaning solutions containing either chloride, including hypochlorite bleaches or hydrochloric acid, can cause unacceptable surface pitting and staining. These should not be used in contact with stainless steels. If wire brushes or wire scouring pads are used, these should be made of stainless steel. Make sure that any abrasive media used is free from sources of contamination, especially iron and chlorides.

Clean the Touch Screen

- 1 Clean the touch screen by wiping with a dry soft cloth or cotton pad as necessary.
- 2 Ensure any moisture is removed immediately to avoid staining or damage to the touch screen.

Note: If necessary, the cloth can be moistened with a little ethanol to remove any dirt.



Caution

EQUIPMENT DAMAGE. Only clean the LCD Screen by wiping with a soft cloth or cotton pad. Water may cause damage or discoloration of the screen. Clean condensation or moisture from any source immediately.

Introduction

This chapter contains the troubleshooting and fault diagnosis information for the everyday users of the printer.

The service manual has more information on troubleshooting for the service technician and trained personnel.



Warning

LETHAL VOLTAGES. Lethal voltages are present within this equipment when the equipment is connected to the main electrical supply. Only trained and authorised personnel must do the maintenance work. Observe all statutory electrical safety codes and practices. Unless it is necessary to run the printer, disconnect the printer from the main electrical supply before you remove the covers or do any service or repair activity. The failure to follow this warning can cause death or personal injury.



Warning

PERSONAL INJURY. It is possible that in a fault condition the heater can reach 70° C. Do not touch the plate on which the heater is installed. The failure to follow this warning can cause the personal injury.

The Printer Does Not Start

- 1 Make sure that the printer is turned on. To turn on the printer, press the green push button.
- 2 Check the system bar (see Table 7-1) to see if a system fault has occurred or if user action is required.

Note: Status bar across the top of the home screen indicates the color of the beacon output.

Status Bar	Beacon	Beacon Output
Blue	GREEN	The jet is running and the printer can print correctly (not in print mode).
Green	GREEN	The printer is in print mode and can print correctly
Yellow	AMBER and GREEN	The printer requires user interference to prevent a system fault. For example, ink or make-up fluid low.
Red	RED	Any fault that prevents the printing. For example, jet not running, deflector plate trip.

Table 7-1: Status Bar

- 3 If the status bar is red or yellow, inspect the display to see the related message are displayed. Refer to “Fault Messages and Warnings” on page 7-7.
- 4 If the status bar is green, and the printer does not print:
 - Make sure that the product sensor and shaft encoder are connected and correctly operating (a lamp found behind the product sensor must flash if a product passes the sensor).
 - If the problem continues, report the fault to Videojet Technologies Inc. at 1-800-843-3610 (United States (US) only). The customers outside the US must contact a Videojet subsidiary office or the local Videojet distributor.
- 5 If the display or beacon (where installed) does not illuminate, check the main electrical supply as follows:
 - a. Make sure that the main electrical supply is available.
 - b. Make sure that the main input connector is fitted correctly.

- c. Make sure that the main power supply button is in the ON position (looks pressed in).
- d. If the problem continues, report the fault to Videojet Technologies Inc. at 1-800-843-3610.

Incorrect Print Position

- 1 Make sure that the *Product Delay* value set in the *Setup > Control* menu is correct. See “Default Message Parameters” on page 5-11.

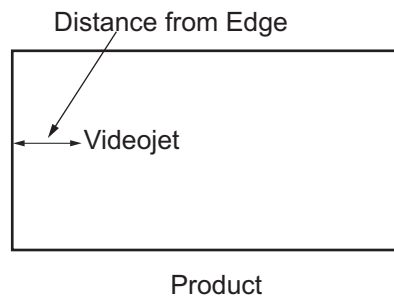

Figure 7-1: Print Position

- 2 Make sure that there are no additional spaces at the start of the message.

Incorrect Print Size

- 1 Make sure that the set character height is correct. Refer to “To Modify Font Attributes” on page 5-57.
- 2 Make sure that the distance from the printhead to the product is correct. The character height increases and resolution decreases as the printhead moves away from the product.

Note: The optimal distance from the printhead to the product for the best quality is 12 mm. The range is 5 to 15mm.

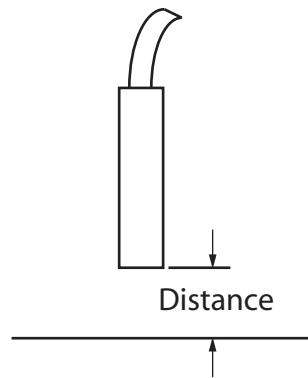

Figure 7-2: Distance from Product

- 3 Make sure that the correct font is selected in the message.
- Note: Refer to Table A-6 on page A-7 for information on the print height.*
- 4 If the message width appears stretched, decrease the width value set in the *Print Position* menu. Refer to “Print Position” on page 4-3.
 - 5 If the message width appears compressed, increase the Width value set in the *Print Position* menu.

Print Not Complete

You must check for any ink deposits on the printhead and clean the printhead if necessary. Refer to “Clean the Printhead” on page 6-7.

Poor Print Quality

PRINT QUALITY TEST

The example on the left shows good overall character formation, no stray drops and an even application of

print.

Table 7-2 describes the samples of bad printing, their causes and the steps required to correct the fault.

Sample and Cause	Remedy
<p>PRINT QUALITY TEST</p> <p>Jet not aligned correctly, or nozzle has a partial block. Note bottom drops clipping the edge of the gutter. Possible EHT too low.</p>	<p>Clean the printhead and printhead cover. Perform the nozzle flush procedure, wash the nozzle with wash down. Make sure that the gutter is clean.</p>
<p>PRINT QUALITY TEST</p> <p>Phasing error. The correct placement of drop is not good. You see a good amount of splashing in the area around.</p>	<p>Clean and completely dry the printhead and the printhead cover. Make sure there is enough time available between prints to phase.</p>
<p>PRINT QUALITY TEST</p> <p>Incorrect modulation, too many satellites, charging process not correct.</p>	<p>Backflush nozzle and check for correct breakup.</p>
<p>PRINT QUALITY TEST</p> <p>Pressure too high, drops not deflected correctly, drops "run in" to one another, small print.</p>	<p>Check for jet alignment. Refer to the service manual for more information.</p>
<p>PRINT QUALITY TEST</p> <p>Pressure too low, the drops are over-deflected or incorrectly positioned. Possible loss of most deflected drops.</p>	<p>Check for jet alignment. Refer to the service manual for more information.</p>

Table 7-2: Samples of Bad Printing

Sample and Cause	Remedy
 <p>Printhead too far from the substrate. The drops are affected by air currents and are spaced too far apart vertically.</p>	<p>Decrease the distance from the substrate, or select a more correct font.</p>
 <p>The Printhead slot not vertical to the substrate travel.</p>	<p>The face of the of the printhead must be at 90 degrees angle to the surface of the substrate and the slot must be vertical to the substrate movement. Refer to the figure below.</p> 

Table 7-2: Samples of Bad Printing (Continued)

Printer Status Icons

The printer status icons are divided into two groups:

- The indicator icons: The indicator icons show the status of the ink

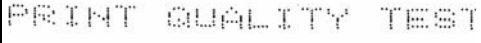
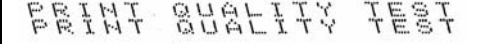
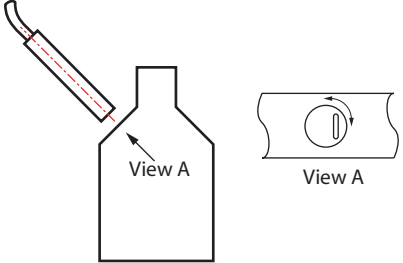

- The printer status bar displaying status as:

- 'RUNNING': It is displayed when the printer is on, jet is running and printing is enabled.



- 'OFFLINE': It is displayed when the printer is on, jet is running and printing is disabled.



- 'SHUTDOWN': It is displayed when the printer is on and jet is not running.

A rectangular status bar with a black border containing the word "SHUTDOWN" in large, bold, black capital letters.

Fault Messages and Warnings

When a fault or warning occurs, the printer displays the fault message in the status bar at the top of all pages. The status bar will turn yellow in case of a warning and it turns red, in case of an alarm as shown below.

A red rectangular status bar with a black border. On the left, the word "FAULT" is written in large, bold, black capital letters. To its right, the text "(E6000) Printhead Absent" is written in a smaller, black font.

Figure 7-3: Fault Message

A yellow rectangular status bar with a black border. On the left, the word "WARNING" is written in large, bold, black capital letters. To its right, the text "(E6082) Charge DAC not zeroed" is written in a smaller, black font.

Figure 7-4: Warning Message

When a fault occurs, the printer's fault output relay will open. If this relay is wired into the packaging machine's stop circuit, it can be used to ensure that the packaging machine is stopped in the event of an error. This prevents the uncoded product from being produced when the printer has a fault.

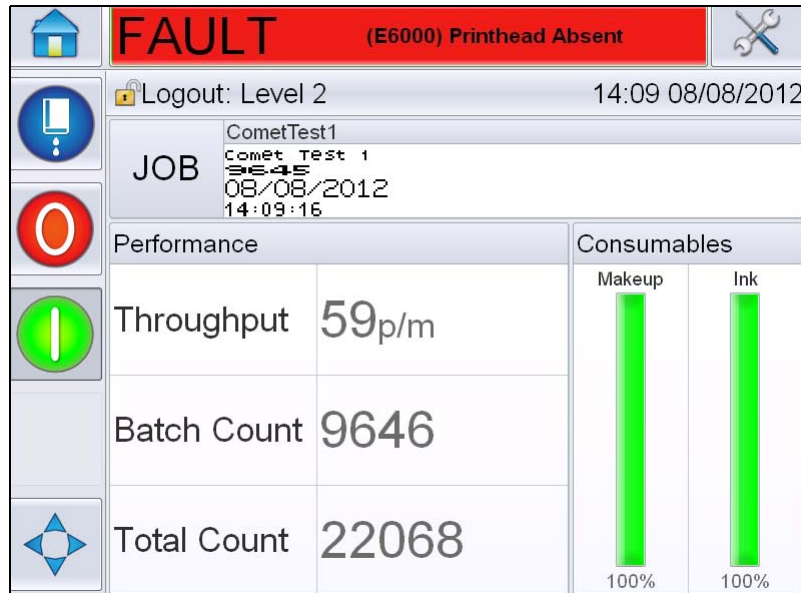

Figure 7-5: Fault Display

Several faults and warnings may occur at the same time. Faults or alarms will always be displayed first.

To view the faults/warnings in more detail and to view instructions on what to do about them, touch the red or yellow area in the status window at the top of the touch screen display.

Clearing a Fault Message or Warning

The instructions in this section provides information on how to clear a fault message. A similar procedure is used to clear warnings.

To view the details of the fault list, proceed as follows:

- 1 Touch the red *FAULT* message to view the list of faults (Figure 7-5 on page 7-8).

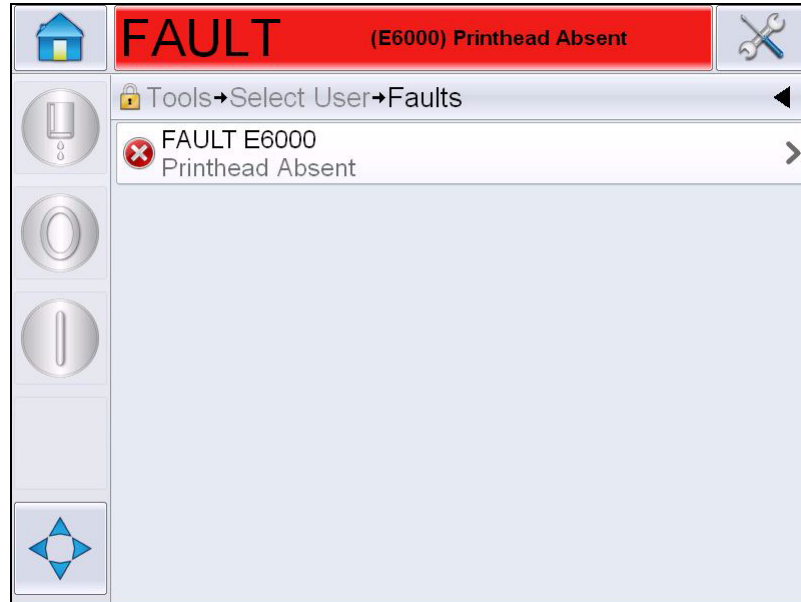

Figure 7-6: Fault Selection

- 2 Touch the fault name in the list to read more details about the fault.



- 3 Read the details of the fault and the on screen instructions that tell you what to do about the fault.

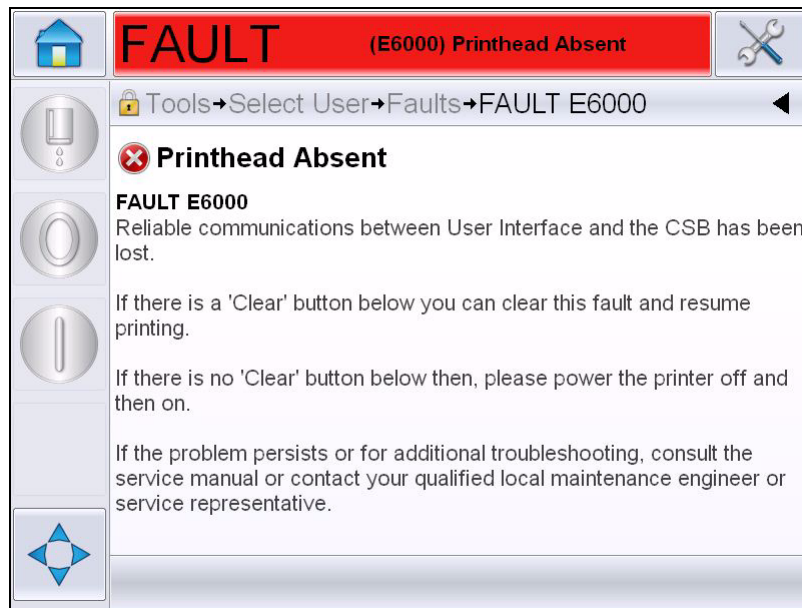

Figure 7-7: Fault Details Display

- 4 When you have corrected the fault, the *Clear* button is activated. Press *Clear* to remove the fault message.

Note: This procedure applies only to 'latched alarms' which remain until you clear them using the "Clear" button. Other alarms will automatically reset when the alarm condition is rectified and need not be cleared manually.

Printer Error Messages

Note: For clearing all alarms, navigate to *Diagnostics > Printhead > Clear errors and warnings*.

Fault (Alarm) Icons

Error Reference	Name	Remedial Action
E6000	Printhead Absent	Reliable communications between User Interface and the CSB has been lost. Power cycle the printer and see if the issue resolves. If not perform a Communications set up. If the problem persists or for additional troubleshooting, consult the service manual or contact your qualified local maintenance engineer or service representative.
E6007	USB Barcode Scanner Not Found	Check connection if barcode scanner is attached.
E6008	EHT/HV Trip	The deflector plate arcing is sensed. Clean the deflector electrodes within the Printhead. Perform an EHT/HV calibration. Perform a nozzle back flush. If the fault persists, consult the service manual or contact qualified local maintenance engineer or service representative.
E6010	Ink Core Empty	If you have fitted a new ink core you will need to fill it. Please follow the current commissioning procedure for steps on how to do this. If the existing core is showing empty and will not fill check the remaining ink core life has not been exceeded. Refer to documentation for ink core life, consult the service manual or contact your qualified local maintenance engineer or service representative.
E6011	Pump Fault	Consult the service manual or contact your qualified local maintenance engineer or service representative.

Table 7-3: Fault (Alarm) Icons

Error Reference	Name	Remedial Action
E6012	Cabinet Too Hot	The printer cabinet temperature is more than 80 degrees Celsius. To prevent any damage, the printer stops automatically. The printer starts after the temperature decreases. Report all overheating incidents to your qualified local maintenance engineer or service representative.
E6014	Unable to control viscosity	Check if the make-up cartridge is empty. If the cartridge is empty, then replace it. If this action does not correct the fault, consult the service manual or contact your local maintenance engineer or service representative.
E6015	Bad Nozzle	Shutdown jet. Check nozzle is correctly fitted. Carry out Nozzle Flush. Restart jet. If the issue persists, consider performing a refresh of the ink in the core. If this action does not correct the fault, consult the service manual or contact your local maintenance engineer or service representative.
E6016	Mod Driver Chip Over Temperature	Mod amplifier hardware shutdown because of amplifier over temperature. Consult the service manual or contact your qualified local maintenance engineer or service representative.
E6017	Fatal Error: No Phase Response From Firmware	Phase data cannot be obtained during start-up. Perform a nozzle back flush. Clean and completely dry the Printhead. If still in error after two attempts, consult the service manual or contact your local maintenance engineer or service representative.
E6021	Initial Phasing Trim Failed	Phase data cannot be obtained during start-up. Perform a nozzle back flush. Clean and completely dry the Printhead. If still in error after two attempts, consult the service manual or contact your local maintenance engineer or service representative.
E6022	Modulation Readback Failed	Hardware error. Consult the service manual or contact your qualified local maintenance engineer or service representative.

Table 7-3: Fault (Alarm) Icons (Continued)

Error Reference	Name	Remedial Action
E6023	Rasters Memory Overflow Detected	Consult the service manual or contact your qualified local maintenance engineer or service representative.
E6024	Valve Error	Hardware error in valve hit/hold drive circuit Consult the service manual or contact your qualified local maintenance engineer or service representative.
E6025	Core Not Filling	Consult the service manual or contact your local maintenance engineer or service representative.
E6026	Insufficient Ink To Fill Core	Remove the empty ink cartridge and insert new ink cartridge.
E6028	New Ink Core Has A Different Ink Reference	Validate that the ink type display matches the ink cartridge inserted. If you are using an existing ink core, replace with the correct ink cartridge. If the ink type has changed, consult the service manual or contact your qualified local maintenance engineer or service representative. Note: <i>If a new ink core has been fitted, this error will be presented and a "copy ink core parameters" will need to be performed.</i>
E6029	EHT/HV Calibration Required	Verify that the printhead is clean and completely dry. Verify that the printhead sleeve is in place and secured correctly. Enter required password. Calibrate EHT/ HV or contact your qualified local maintenance engineer or service representative.
E6064	Pump Fault	Consult the service manual or contact your qualified local maintenance engineer or service representative.
E6089	Charge Supply Fault	Consult the service manual or contact your qualified local maintenance engineer or service representative.

Table 7-3: Fault (Alarm) Icons (Continued)

Error Reference	Name	Remedial Action
E6090	Gutter Fault	Verify the Ink Stream is present and aligned with the gutter. If not back flush the nozzle. If the ink stream is present but not aligned, follow alignment procedure. If the ink stream is present and is in the gutter, refresh the ink. If the ink stream is present and is in the gutter and the gutter fault persists there may be a possible gutter sensor fault this may require the nozzle deck to be replaced. If the Ink Stream is not present or the issue blocking persists there may be a possible umbilical issue. At any time consult the service manual or contact your qualified local maintenance engineer or service representative.
E6139	Core Service Required	The Core has greatly exceeded its rated life and must be serviced in order to continue printer operation. Consult the service manual or contact your qualified local maintenance engineer or service representative.

Table 7-3: Fault (Alarm) Icons (Continued)

Warning Icons

Error Reference	Name	Remedial Action
E6001	Unsupported Ink Core	If the wrong type of ink core is fitted to the printer you will be unable to continue operation. Consult the service manual or contact your qualified local maintenance engineer or service representative.
E6002	Ink Cartridge Expired	Ink past the expiry date. Insert a new ink cartridge.
E6003	Make-up Cartridge Expired	Make-up past the expiry date. Insert a new make-up cartridge.
E6039	Head Temperature Too High	The measured printhead temperature is more than 3° Celsius above the target temperature. Consult the service manual or contact your qualified local maintenance engineer or service representative.

Table 7-4: Error Messages

Error Reference	Name	Remedial Action
E6040	Head Temperature Too Low	The measured printhead temperature is more than 3° Celsius below the target temperature. Consult the service manual or contact your qualified local maintenance engineer or service representative.
E6041	TOF Too High	The measured jet velocity is more than 10% above the target jet velocity. Consult the service manual or contact your qualified local maintenance engineer or service representative.
E6042	TOF Too Low	The measured jet velocity is more than 10% below the target jet velocity. Consult the service manual or contact your qualified local maintenance engineer or service representative.
E6044	Head Cover Removed	Check the printhead cover installation. Make sure the printhead cover is completely seated on the printhead, ensure the printhead is slid completely into the sleeve. Confirm that the magnet is present on the end of the sleeve, Cover switch may be faulty and need replacing, consult the service manual or contact your qualified local maintenance engineer or service representative.
E6045	Phase Threshold Error	The printer is unable to acquire a phase profile with the phase threshold set to the minimum value. Consult the service manual or contact your qualified local maintenance engineer or service representative.
E6046	Ink Viscosity Too High	Pressure set point for correct velocity is greater than calculated pressure by more than 0.1 bar. Consult the service manual or contact your qualified local maintenance engineer or service representative.
E6047	Ink Viscosity Too Low	Pressure set point for correct velocity is greater than calculated pressure by more than 0.1 bar. Consult the service manual or contact your qualified local maintenance engineer or service representative.

Table 7-4: Error Messages (Continued)

Error Reference	Name	Remedial Action
E6048	Pressure Too High	The actual pressure is more than 0.2 bar above the target pressure. Consult the service manual or contact your qualified local maintenance engineer or service representative.
E6049	Pressure Too Low	The actual pressure is more than 0.2 bar below the target pressure. Consult the service manual or contact your qualified local maintenance engineer or service representative.
E6050	No Ink Cartridge	No ink cartridge present. Insert a new ink cartridge.
E6051	Wrong Ink Cartridge	The cartridge inserted into the ink cartridge holder contains the wrong ink type. Fluid reference and fluid type must match ink core module. These can be identified by looking at smart chip data from the printer and comparing it to the ink cartridge label specifications. If the problem persists, consult the service manual or contact your qualified local maintenance engineer or service representative.
E6053	Ink Cartridge Low	Ink Cartridge is nearly empty. Ensure a full ink cartridge is available for replacement when the current ink cartridge becomes empty.
E6054	Ink Cartridge Empty	Insert a new ink fluid cartridge. The part number of the ink fluid is also displayed. If the problem persists or for additional troubleshooting, consult the service manual or contact your qualified local maintenance engineer or service representative.
E6055	Ink Insertions Exceeded	The current ink cartridge has been inserted more than ten times. It is recommended to insert a new ink cartridge to maintain the cartridge integrity
E6056	No Make-up Cartridge	No make-up fluid available for addition to the ink core module. Insert a new make-up cartridge.

Table 7-4: Error Messages (Continued)

Error Reference	Name	Remedial Action
E6057	Wrong Make-up Cartridge	The cartridge inserted into the make-up fluid cartridge holder contains the wrong make-up fluid type. Fluid reference and fluid type must match ink core module. These can be identified by looking at smart chip data from the printer and comparing it to the ink cartridge label specifications. If the problem persists, consult the service manual or contact your qualified local maintenance engineer or service representative.
E6059	Make-up cartridge low	Make-up cartridge is nearly empty. Ensure a full make-up cartridge is available for replacement when the current make-up cartridge becomes empty.
E6060	Make-up Cartridge Empty	Insert a new make-up fluid cartridge. The part number of the make-up fluid is also displayed. If the problem persists or for additional troubleshooting, consult the service manual or contact your qualified local maintenance engineer or service representative.
E6061	Make-up Insertions Exceeded	The current make-up cartridge has been inserted more than ten times. It is recommended to insert a new make-up cartridge to maintain the cartridge integrity.
E6062	Ink Core Level High	Ink level in the ink core module is very high. Check printer is level. If printer is level and warning is still present, remove some of the fluid from ink core, consult the service manual or contact your qualified local maintenance engineer or service representative.
E6063	Ink Core Level Low	Check whether the ink cartridge is empty. Replace with a new ink cartridge. If an empty ink cartridge is replaced with a full cartridge while the jet is running, the printer will automatically top-up the core. If the problem persists or for additional troubleshooting, consult the service manual or contact your qualified local maintenance engineer or service representative.

Table 7-4: Error Messages (Continued)

Error Reference	Name	Remedial Action
E6066	Pump RPM Near Max	Pump near maximum RPM and pressure is low. Consult the service manual or contact your qualified local maintenance engineer or service representative.
E6067	Cabinet Hot	The electronics compartment is above 70° Celsius. Consult the service manual or contact your qualified local maintenance engineer or service representative.
E6068	Product Detector Too Close To Printhead	Check that the distance between the Printhead and product detector is correct relative to the line running parameters and increase gap or adjust product as appropriate. If the problem persists or for additional troubleshooting, consult the service manual or contact your qualified local maintenance engineer or service representative.
E6069	Gap Between Prints Too Short	The delay between prints is too small or short. Consult the service manual or contact your qualified local maintenance engineer or service representative.
E6070	Print Overlap	The print has started before the end of the current print. Consult the service manual or contact your qualified local maintenance engineer or service representative.
E6071	No Time to Phase	Check that the product detect and the printhead are in the correct position. Consult the service manual or contact your qualified local maintenance engineer or service representative.
E6072	No time for TOF	The printer is unable to get an “actual velocity” and thus cannot perform TOF velocity control. Check whether the product detector and the printhead are in the correct position. Consult the service manual or your qualified local maintenance engineer or service representative.
E6073	Overspeed	The line speed exceeds current print raster (matrix) to get the print width that you need. If the print width is not acceptable, consult the service manual or contact your qualified local maintenance engineer or service representative.

Table 7-4: Error Messages (Continued)

Error Reference	Name	Remedial Action
E6074	Product Queue Too Deep	There are too many products between the product detect and the printhead. Consult the service manual or contact your qualified local maintenance engineer or service representative.
E6075	No Valid Ink Parameters	Consult the service manual or contact your qualified local maintenance engineer or service representative.
E6076	Possible Ink Coefficient Update	Consult the service manual or contact your qualified local maintenance engineer or service representative.
E6077	USB Connection Is Over Current	External USB device requesting excessive current. Replace with alternative external USB device. If the problem persists or for additional troubleshooting, please consult the service manual or contact your qualified local maintenance engineer or service representative.
E6078	Suspected Head Heater Failure (Or Thermal Trip)	Consult the service manual or contact your qualified local maintenance engineer or service representative.
E6079	Tank Not Filling	Ink core module still at low level after 5 attempts to add ink to increase level. Consult the service manual or contact your qualified local maintenance engineer or service representative.
E6080	DAC Overflow	Hardware fault (Digital to Analogue Converter). Consult the service manual or contact your qualified local maintenance engineer or service representative.
E6081	DAC Comms Error	Hardware fault (Digital to Analogue Converter). Consult the service manual or contact your qualified local maintenance engineer or service representative.
E6082	Charge DAC Not Zeroed	Hardware fault (Digital to Analogue Converter). Consult the service manual or contact your qualified local maintenance engineer or service representative.

Table 7-4: Error Messages (Continued)

Error Reference	Name	Remedial Action
E6083	Unable To Compensate For Throw Distance	The print delay is too small or short. Adjusting the printhead position and throw distance may rectify this issue. If the problem persists or for additional troubleshooting, consult the service manual or contact your local maintenance engineer or service representative.
E6086	Creating Raster Catalog	Software is busy. Raster is being replaced and the printer cannot print. Wait for the raster catalogue to complete. If the problem persists or for additional troubleshooting, consult the service manual or contact your qualified local maintenance engineer or service representative.
E6087	Incorrect Raster or Raster Family Name	Requested raster table not loaded into system. Consult the service manual or contact your qualified local maintenance engineer or service representative.
E6091	Printhead Cover Detect Disabled	By default the Printhead Cover Detect is enabled. If you are seeing this warning it means the detection has been disabled. Please proceed with caution.
E6093	Error Sensing Ink Core Low Level Probe	If the problem persists or for additional troubleshooting, consult the service manual or contact your qualified local maintenance engineer or service representative.
E6094	Error Sensing Ink Core Mid Level Probe	If the problem persists or for additional troubleshooting, consult the service manual or contact your qualified local maintenance engineer or service representative.
E6095	Error Sensing Ink Core High Level Probe	If the problem persists or for additional troubleshooting, consult the service manual or contact your qualified local maintenance engineer or service representative.
E6096	Error Sensing Gutter Probe	If the problem persists or for additional troubleshooting, consult the service manual or contact your qualified local maintenance engineer or service representative.

Table 7-4: Error Messages (Continued)

Error Reference	Name	Remedial Action
E6097	Missed Print (PD Too Close To Printhead)	Missed print because product detector is too close to Printhead. Check that the distance between the Printhead and product detector is correct relative to the line running parameters and increase gap or adjust product as appropriate. If there is a 'Clear' button below you can clear this fault and resume printing. If there is no clear button below, go to <i>Tools > Diagnostics > printhead > Clear Errors And Warnings</i> . If the warning still does not clear, power cycle the printer. If the problem persists or for additional troubleshooting, consult the service manual or contact your qualified local maintenance engineer or service representative.
E6098	Missed Print (Gap Between Prints Too Short)	Missed print because the gap between prints is too small or short. If there is a 'Clear' button below you can clear this fault and resume printing. If there is no clear button below, go to <i>Tools > Diagnostics > printhead > Clear Errors And Warnings</i> . If the warning still does not clear, power cycle the printer. If the problem persists or for additional troubleshooting, consult the service manual or contact your qualified local maintenance engineer or service representative.
E6099	Missed Print (Print Overlap)	Missed print because the print has started before the end of the current print. If there is a 'Clear' button below you can clear this fault and resume printing. If there is no clear button below, go to <i>Tools > Diagnostics > printhead > Clear Errors And Warnings</i> . If the warning still does not clear, power cycle the printer. If the problem persists or for additional troubleshooting, consult the service manual or contact your qualified local maintenance engineer or service representative.

Table 7-4: Error Messages (Continued)

Error Reference	Name	Remedial Action
E6100	Missed Print (Product Queue Too Deep)	Missed print because there are too many products between the product detect and the Printhead. If there is a 'Clear' button below you can clear this fault and resume printing. If there is no clear button below, go to <i>Tools > Diagnostics > printhead > Clear Errors And Warnings</i> . If the warning still does not clear, power cycle the printer. If the problem persists or for additional troubleshooting, consult the service manual or contact your qualified local maintenance engineer or service representative.
E6107	Valve Module Needs Replacing Soon	Consult the service manual or contact your qualified local maintenance engineer or service representative.
E6108	Valve Module Needs Replacing	Consult the service manual or contact your qualified local maintenance engineer or service representative.
E6109	Insufficient System Memory	Consult the service manual or contact your qualified local maintenance engineer or service representative.
E6110	Ink Cartridge Not Fitted	No ink cartridge present. Insert a new ink cartridge.
E6115	Print Stopped	Check printer and line status. If there are no issues present, enable print.
E6116	Viscosity Not Calibrated	Consult the service manual or contact your qualified local maintenance engineer or service representative.
E6127	Internal Crash Dump Available	The printer's internal processor has recovered from a crash. To collect the details of this crash, please contact your qualified local maintenance engineer or service representative who can aid you with recovering this data.
E6138	Core has reached its rated life	Core has reached its rated life. The Core should be serviced as soon as possible to reduce the risk of unplanned downtime. Consult the service manual or contact your qualified local maintenance engineer or service representative.

Table 7-4: Error Messages (Continued)

Error Reference	Name	Remedial Action
E6140	Core Service Overdue	The Core has limited hours of available operation remaining. The remaining hours of operation can be viewed from <i>Tools > Diagnostics > Consumables > Ink Core > Remaining Hours</i> . It is strongly recommended the core should be serviced before this period has expired to prevent unplanned downtime. Consult the service manual or contact your qualified local maintenance engineer or service representative.

Table 7-4: Error Messages (Continued)

Ink Core Life

Videojet 1560	61 months
---------------	-----------

Table 7-5: Ink Core Life

Fault Messages

Fault messages are displayed on the top status bar. The messages are arranged so that, if more than one fault is found, only the most serious fault message is displayed on the top status bar. All alarms and warnings are listed on the alarm and warning page (accessed by touching status bar).

Diagnostics Screen

The diagnostic screen shows the current value of different parameters which help you in troubleshooting the printer. Refer “Working with Diagnostics” on page 5-13.

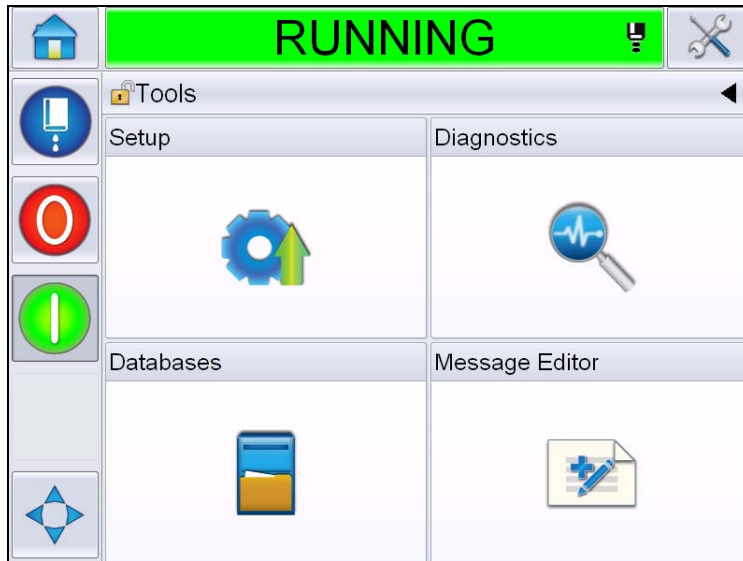

Figure 7-8: Diagnostics Screen

Specifications

A

Electrical Specifications

The electrical specifications of the printer are shown in Table A-1.

Voltage	100 V AC to 240 V AC
Frequency	50 Hz to 60 Hz
Power Consumption	120 watts Maximum

Table A-1: Electrical Specifications

Weight

The dry weight specification of the printer is shown in Table A-2.

Dry weight	22 kg
------------	-------

Table A-2: Weight Specifications

Dimensions

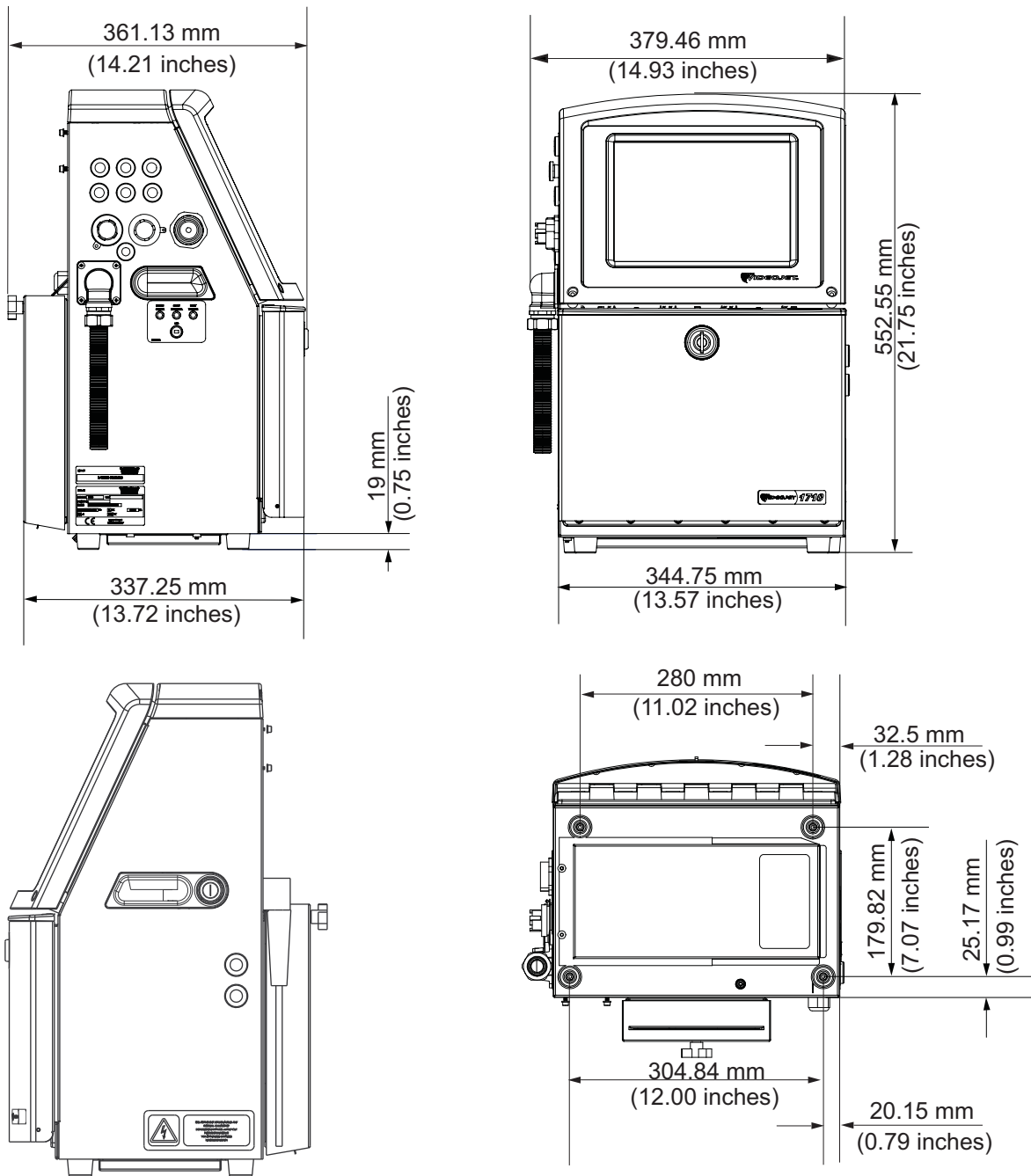

Figure A-1: Printer Dimensions

The dimensions of the printer are shown in Table A-3.

Cabinet	Width	345 mm
	Height	553 mm
	Depth	361 mm
Printhead	Diameter	Ø41.3 mm
	Diameter of the nozzle orifice	60 and 70 Microns
Umbilical length	Videojet 1560 3 Meter Standard 6 Meter Optional	3 or 6 m
Cabinet Variations	Standard IP55 Optional IP65	-

Table A-3: Printer Dimensions

Optional Accessories

Mobile Printer Stand

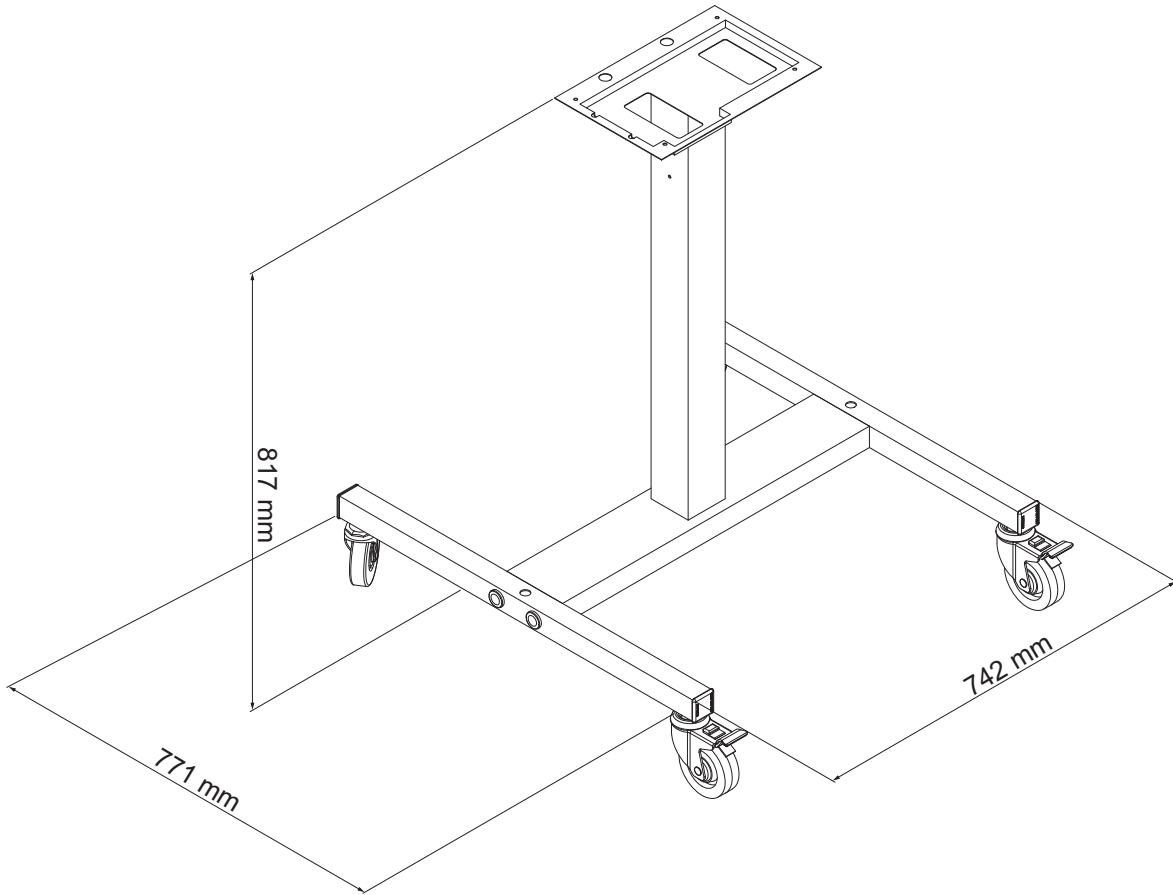

Figure A-2: Mobile Printer Stand Dimensions

Static Printer Stand

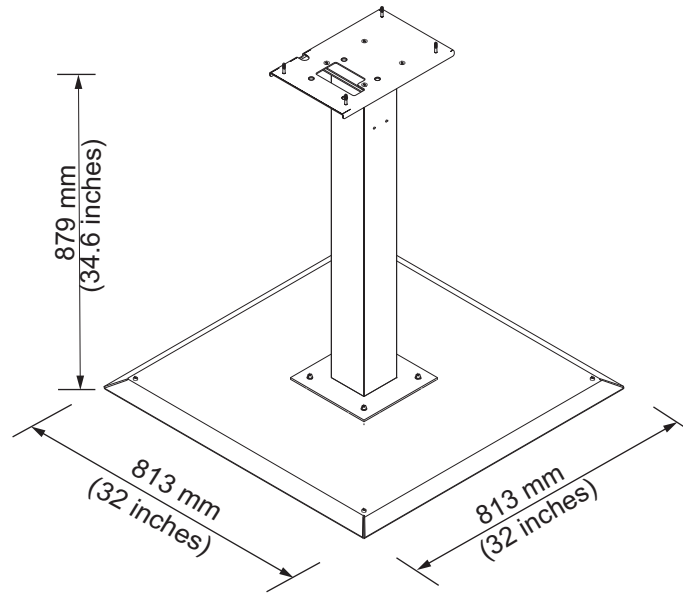

Figure A-3: Static Printer Stand

Printhead Stand

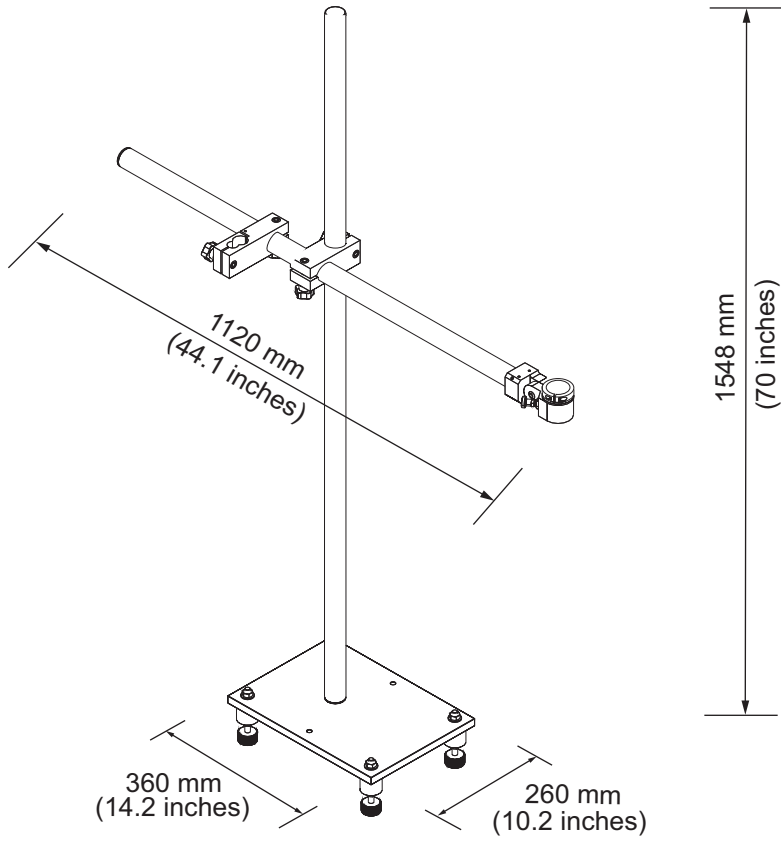

Figure A-4: Printhead Stand

Environmental Specifications

The environmental specifications of the printer are shown in Table A-4

Operating temperature	5 °C to 45 °C (41 °F to 113 °F)*
Rate of change of ambient temperature	10 °C (18 °F) per hour maximum
Relative humidity	0% to 90% non-condensing*
Storage temperature	5 °C to 50 °C (41 °F to 122 °F) in original packaging
Industrial-protection rating	IP55 is standard and IP65 is optional for Videojet 1560.

Table A-4: Environmental Specifications

***Note:** When the printer is operated in an environment with elevated humidity, or with certain inks (including water sensitive inks), air dryers or other items may be required. Please contact Videojet Technologies Inc. at 1-800-843-3610 (for all customers within the United States) Outside the U.S., customers should contact their Videojet Technologies Inc. distributor or subsidiary for assistance.

Ink and Make-up Fluid Capacity

The ink and solvent capacity of the printer are shown in Table A-5.

Ink Cartridge	750 milliliters
Make-up Fluid Cartridge	750 milliliters

Table A-5: Ink and Make-up Fluid Capacity

Print Height

The minimum and maximum height of the message for the print matrix is shown in Table A-6.

2 mm	Minimum
12 mm	Maximum

Table A-6: Print Height

Font Specifications and Line Speeds

The font specifications and the line speeds for 60 and 70 micron nozzle are shown in Table A-7.

Note: The line speeds listed in the Table A-7 are for 60 dpi only.

Line Mode	Height	Width	Cal Speeds			
			70 Micron		60 Micron	
			ft/min	m/min	ft/min	m/min
1	5	5	914	279	914	279
1	7	4	960	293	960	293
1	7	5	800	244	800	244
1	9	7	356	108	356	108
1	12	9	256	78	256	78
1	16	10	200	61	194	59
1	24	16	96	29	96	29
1	34	25	53	16	56	17
2	5	5	256	78	256	78
2	7	4	240	73	320	98
2	7	5	200	61	267	81
2	9	7	119	36	125	38
2	12	9	85	26	85	26
2	16	10	53	16	56	17
3	5	5	119	36	125	38
3	7	4	108	33	108	33
3	7	5	90	27	90	27
3	9	7	53	16	56	17
4	5	5	85	26	85	26
4	7	4	64	20	67	20
4	7	5	53	16	56	17
5	5	5	53	16	56	17

Table A-7: Line Speeds

Barcode Specifications

The available barcode types are shown in Table A-8.

Note: Barcode specification and Data Matrix are listed in the Table A-8 and Table A-9. Barcodes run at single line speed based on height selected at 60 dpi. This is only available through CLARiSOFT®.

Barcode Type
UPCA
UPCE
EAN8
EAN13
Code 128 (A, B and C)
UCC/EAN 128
2 of 5I
Code 39
2D Data Matrix
2D Data Matrix rectangular (*GS1)

Table A-8: Barcodes Matrix

Data Matrix
10 x 10
12 x 12
14 x 14
16 x 16
18 x 18
20 x 20
22 x 22
24 x 24
26 x 26
32 x 32

Table A-9: Data Matrix Code Sizes

Data Matrix
8 x 18
8 x 32
12 x 26
12 x 36
16 x 36
16 x 48

Table A-9: Data Matrix Code Sizes (Continued)

Note: The 60 Micron Nozzle is recommended to print datamatrix codes at 16 high or taller.

Glossary

Availability

The amount of time that an equipment is ready to run when required for production.

Batch Counter/ Product Counter

The counter that displays the number of prints in the batch or product.

Character Set

The character sets are a combination of number of different language alphabets and special text characters that are programmed in the printer.

Charge

The electrical charge that is applied to the small drops of ink. The amount of charge applied depends on the destination of the drop on the substrate.

CIJ

In the CIJ technology a continuous stream of ink breaks into small ink drops, and these ink drops are deflected to form the characters and images on the substrate

Clean Start

Clean start is a printer start sequence which removes the splashing of ink and spray during the startup. This startup sequence is used if Clean Stop was used earlier to stop the printing.

Clean Stop

Clean Stop feature provides the required time to remove the ink from the manifold and nozzle before the ink jet stops. This action prevents any deposits of ink on the printhead. A clean printer operates correctly for longer periods of time.

Deflector Plate

The deflector plate creates a high voltage field in the printhead. The high voltage field deflects ink droplets for printing. You can change the voltage in the deflector plate to control the character height.

Gutter

The ink not used by the printhead returns through the gutter.

Icon

A graphical symbol used to indicate a printer state or error condition.

LCD

LCD is a thin, flat display device made up of any number of color or monochrome pixels arrayed in front of a light source or reflector.

LED

LED is a semiconductor device that emits visible light when an electric current passes through it.

Message Select

The method to select the message from an external source and not through the keypad. External source like the Programmable Logic Controller (PLC) or a switch box.

Nozzle

Ink is supplied to the nozzle assembly and pushed through a small orifice. The nozzle assembly is made to vibrate to break the ink jet into a continuous stream of small drops of ink.

Parameters

The settings which are applied to the message that is printed. For example, message width.

Phasing

The microprocessor control system of the printer monitors the data from the phase detector. This data make sure that there is synchronization between the charging of small ink drops and their break up.

Photocell

A light activated switch that detects the presence of the product to start the printing.

Product Detector: Photocell

Product Delay

The product delay is the time from when the photocell is activated and the message begins to print.

Quick Start

Quick Start is used if the machine is turned off for only less than 30 minutes. This start mode of the printer is used where the nozzle is not flushed.

Quick Stop

Quick Stop is used if the machine will be off for less than 30 minutes. This type of stop mode of the printer is used where the nozzle is full of ink.

Rounded Dates

Pull Dates: Rounded Dates

RS-232

Serial data communications standard which enables the communication between the printer and other devices.

Satellites

Small additional drops of ink in the ink stream caused by incorrect modulation settings.

Shaft Encoder

A device that senses the changes in the product speed and enables the printer to adjust the print width.

Substrate

The product surface where the printing occurs.

User Fields

A user field is inserted into a message. The user field is copied into the message during the print operation only, so that the user field includes the new updates. (For example, expiry date).

Valve

The hydraulic component in the printer to control the flow of ink within the printer.

Washdown

A cleaning solution which cleans the printhead and removes any additional deposits of ink.

WYSIWYG

WYSIWYG is an acronym for What You See Is What You Get, used in computing to describe a system in which content displayed during editing appears very similar to the final output (in this case, characters and images printed on the substrate).